



ABC Combi Electric Oven

ABC7E	ML-137716	208 / 240 / 480
	ML-137718	208P / 240P / 480P

- NOTICE -

This Manual is prepared for the use of trained Hobart Service Technicians and should not be used by those not properly qualified.

This manual is not intended to be all encompassing. If you have not attended a Hobart Service School for this product, you should read, in its entirety, the repair procedure you wish to perform to determine if you have the necessary tools, instruments and skills required to perform the procedure. Procedures for which you do not have the necessary tools, instruments and skills should be performed by a trained Hobart Service Technician.

The reproduction, transfer, sale or other use of this manual, without the express written consent of Hobart, is prohibited.

This manual has been provided to you by ITW Food Equipment Group LLC ("ITW FEG") without charge and remains the property of ITW FEG, and by accepting this manual you agree that you will return it to ITW FEG promptly upon its request for such return at any time in the future.

TABLE OF CONTENTS

SERVICE UPDATES	4
SERVICE UPDATES - ABC COMBI ELECTRIC OVEN	4
TIS DOCUMENT LIST - ABC COMBI ELECTRIC	4
GENERAL	6
INNER DOOR LATCH	6
INTRODUCTION	6
OPERATION, CLEANING AND MAINTENANCE	6
TOOLS	6
LUBRICATION	7
WATER QUALITY STATEMENT	7
SPECIFICATIONS	8
UPGRADE ABC COMBI FIRMWARE	9
FIRMWARE VERSION HISTORY	9
FIRMWARE UPDATE PROCEDURE	11
USB ERROR MESSAGES	12
REMOVAL AND REPLACEMENT OF PARTS	14
PANELS	14
INNER DOOR	15
DOOR LAMP	15
DOOR LATCH	16
DOOR SWITCH	17
DOOR SEAL	18
MAIN CONTROL BOARD	18
OXYGEN SENSOR	19
OXYGEN SENSOR BOARD	19
FERRITE	21
MOTOR CONTROL BOARD	21
CONTROL BOX COOLING FAN	22
CONTROL PANEL	22
CONTROL PANEL COOLING FAN	24
ON / OFF SWITCH	25
KNOB & ENCODER	25
DISPLAY BOARD	26
MEAT PROBE SOCKET	27
REAR COOLING FAN	28
HIGH-LIMIT THERMOSTAT	28
CAVITY INTAKE TUBE ASSEMBLY	29
CAVITY VENT MOTOR	30
CAVITY VENT SWITCHES	31
TRANSFORMER	32
TEMPERATURE SENSOR (RTD1)	33
DRAIN WATER CONDENSATE VALVE	34
DRAIN WATER THERMOCOUPLE	35
HUMIDITY VALVE	36
CONVECTION FAN BAFFLE	36
CONVECTION FAN MOTOR	37
HEATING ELEMENTS	39
CONTACTORS	41
SERVICE PROCEDURES AND ADJUSTMENTS	43
CONFIGURATION MODE (1972) ELECTRIC	43
CALIBRATING OXYGEN SENSOR BOARD	50
CHECK OXYGEN SENSOR DATE CODE (REPLACEMENT SENSORS)	51
TEMPERATURE SENSOR (RTD1) TEST	52

TEMPERATURE CALIBRATION - ELECTRIC	52
EXTERNAL MEAT PROBE THERMOCOUPLE CALIBRATION	53
CAVITY VENT SWITCH TEST AND ADJUSTMENT	53
DOOR TO CONTROL PANEL ALIGNMENT	55
DOOR SWITCH ADJUSTMENT	58
TRANSFORMER RESISTANCE CHECK	58
MOTOR RESISTANCE CHECK	60
HEATING ELEMENTS RESISTANCE CHECK	62
ELECTRICAL OPERATION	64
COMPONENT FUNCTION	64
CONTROL PANEL COMPONENT LOCATIONS	66
SEQUENCE OF OPERATION	67
CONDITIONS	67
ON/OFF SWITCH (SW4) TURNED ON, (NO CALL FOR HEAT)	68
ON/OFF SWITCH (SW4) ON & WITH CALL FOR HEAT	69
ON/OFF SWITCH (SW4) ON & WITH CALL FOR HEAT & CALL FOR HUMIDITY	70
OTHER SEQUENCES	71
CIRCUIT BOARD LAYOUTS	73
MAIN BOARD CONNECTIONS	73
MOTOR BOARD	76
WIRING DIAGRAMS	77
TERMINAL BLOCKS	77
T1 TRANSFORMER	78
HEATING ELEMENTS	79
MAIN BOARD	80
MOTOR BOARD	81
COOLING FANS	82
WIRING CHANGES FOR SINGLE PHASE	82
DIAGNOSTICS / TROUBLESHOOTING	84
SERVICE MODE (1963)	84
ERROR CODES	91
OVEN TROUBLESHOOTING	95
QUICK OVER ALL CHECK	96
TROUBLESHOOTING USING ERROR CODES	96
TROUBLESHOOTING BY SYMPTOM	104

SERVICE UPDATES

SERVICE UPDATES - ABC COMBI ELECTRIC OVEN

March 2023

1. Added DOOR SEAL.

November 2021

1. Updated CONTROL PANEL.

April 2020

1. Updated HEATING ELEMENTS.
2. Updated TOOLS.

June 2018

1. Updated all chapters due to firmware update in this service manual.

Upgrade ABC Combi Firmware 04-24-17

2. FIRMWARE VERSION HISTORY
3. FIRMWARE UPDATE PROCEDURE

January 2015

1. New Heating Element Wiring Diagram - 05-20-15
2. New Software version - 08-11-14
 - A. FIRMWARE VERSION HISTORY
 - B. FIRMWARE UPDATE PROCEDURE
 - C. USB ERROR MESSAGES

TIS DOCUMENT LIST - ABC COMBI ELECTRIC

SERVICE TAB	
Document Title	Document Type
ABC Combi Electric Service Manual	Service Manual
ABC Combi Ovens - Door-to-Control Panel Alignment Service Kit Instructions	Service Kit Instructions (SKI)
ABCG & ABCE Combi Stacking Kit	Service Kit Instructions (SKI)
ABC Combi Element Thread Change: Standard to Metric	Service Kit Instructions (SKI)

SERVICE TAB (Multimedia)	
Document Title	Document Type
Did You Know - ABC Combi	Misc.
Repair Flood-Damaged Equipment	Service Bulletin
ABC Gas and Electric Combi Ovens I&O Manual	Operator
ABC Combi Door Seal Replacment	Video
Hobart Water Filter Replacement Cross Reference Sheet	Service Instructions
ScaleStick Twin system, Part No. 01-234301-51200 Installation Instructions	Service Instructions
ABC7E Electric Combi Oven Spec Sheet	Specification Sheet
Rating Plate Locations on Current Vulcan-Hart	Technical Service Bulletin (TSB)
TSB 1393 Steam Cooking Equipment - Prevention, Detection and Treatment of Corrosion on Stainless Steel	Technical Service Bulletin (TSB)
TSB 1037A Hobart to Vulcan "Common" Model Cross Reference List	Technical Service Bulletin (TSB)

PARTS TAB	
Document Title	Document Type

PARTS TAB	
ABCE Combi Parts Catalog	Parts Catalog

DIAGRAMS TAB	
Document Title	Document Type
ABC Combi Electric Wiring Diagram	Wiring Diagram

TROUBLESHOOTING TAB	
Document Title	Document Type
ABC Combi Electric Troubleshooting	Troubleshooting

GENERAL

INNER DOOR LATCH

1. Remove INNER DOOR.
2. Remove upper door stiffener screws from both ends and remove upper door stiffener.

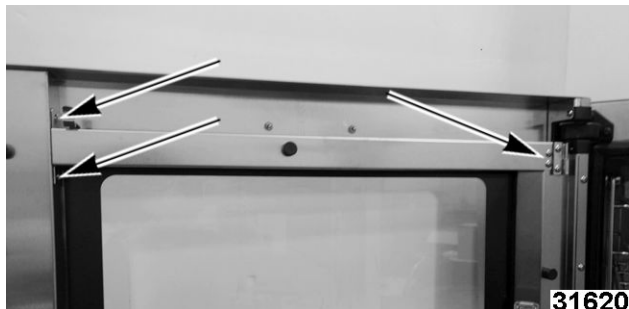

Fig. 1

3. Remove inner door latch screws.

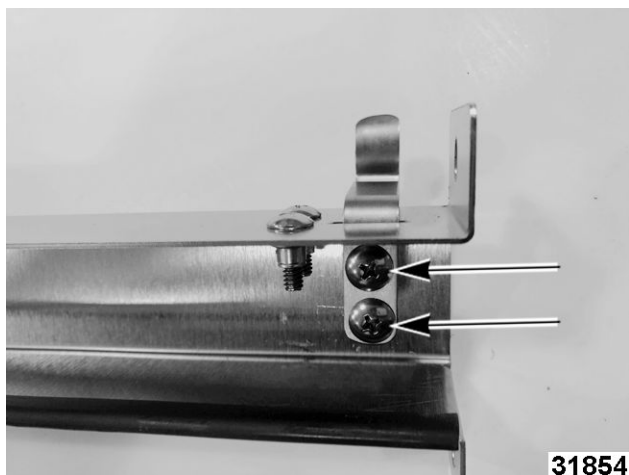

Fig. 2

4. Reverse procedure to install.

NOTICE

Apply Blue Loctite 243 to inner door latch screws and inside stiffener screws.

NOTICE

Apply Purple Loctite 222 to the upper door stiffener screws.

NOTICE

Tighten screws to 24 in. lb.; do not overtighten.

5. Check for proper operation.

INTRODUCTION

General

This manual is for ABC7 Combi ovens. Ovens feature a powered vent damper, and an advanced digital control panel with digital display for setting cook TEMPERATURE, TIME, and HUMIDITY.

Heating

The ABC Combi oven reaches baking temperature of 350°F at 0% humidity in approximately 5½ to 6 minutes; however, a 20-minute preheat is recommended.

Combi Ovens

Combi ovens provide convection heat, steam heat or a combination of both in a single compartment cooking chamber. Humidification is provided by water injection into oven cavity. Water is injected by means of an internal nozzle, and vaporizes on contact with hot interior surfaces.

Steam System

All combi ovens come with a boilerless flash steaming system which provides a quick response time as well as excellent cooking results.

All information, illustrations and specifications contained in this manual are based on latest product information available at time of release.

OPERATION, CLEANING AND MAINTENANCE

Refer to Installation & Operation Manual (F47110) for specific operating instructions.

TOOLS

Standard

1. Standard set of hand tools.
2. Metric set of hand tools.
3. VOM with minimum of NFPA-70E CAT III 600V, UL/CSA/TUV listed. Sensitivity of at least 20,000 ohms per volt. Meter leads must also be rated at CAT III 600V. Clamp on type amp meter with minimum of NFPA-70E CAT III 600V, UL/CSA/TUV listed.
4. Temperature tester (thermocouple type).

5. Field service grounding kit.

Special

1. Loctite®243, Loctite®222, Loctite®272.
2. M6 socket head cap screw 3" long (hardened black oxide finish) for removing convection fan from motor shaft.
3. Pass-through socket and ratchet or several M12 deep well sockets welded together for HEATING ELEMENTS.
4. Gear puller to remove CONVECTION FAN BAFFLE.
5. USB Drive (Part # 00-443444).
6. No-Go / Go Gauges for DOOR TO CONTROL PANEL ALIGNMENT.
 - A. No-Go Gauge - .200"
 - Use .032", .030", .028", .025", .022", .020", .018", .015", and .010" feeler gauges to make a .200" No-Go gauge.



Fig. 3

- B. Go gauge - .119"
 - Use .032", .030", .028", .025" and .004" feeler gauges to make a .119" Go gauge.

LUBRICATION

NOTE: Ovens have self-lubricating composite bearings. No lubrication required.

WATER QUALITY STATEMENT

The fact that a water supply is potable is no guarantee that it is suitable for steam generation. Proper water quality can improve the taste of the food prepared in the oven, reduce scale build-up or corrosion, and extend equipment life. Local water conditions vary from one location to another and can change throughout the year. The recommended water treatment for effective and efficient use of this

equipment will vary depending on the local water conditions. Your water supply must be within the general guidelines outlined in the chart below at all times during use of this machine or service issues not covered under warranty may result.

Water hardness should be treated by removing the impurities (water softener with carbon block or dechlorinator and/or in-line water treatment). Low water hardness may also require a water treatment system to reduce potential corrosion. Water treatment has been shown to reduce costs associated with machine cleaning, reduce deliming and reduce corrosion of metallic surfaces.

Daily washing and rinsing of the cavity is required. In some cases, it may be needed more than once a day to prevent compounding of contaminants deposited inside cavity even with acceptable filtration. Failure to wash and rinse down the cavity daily could result in damage of the oven cavity and interior parts. A Reverse Osmosis water treatment system can be installed to eliminate chlorides or other contaminants from the water if needed.

NOTE: Failure to properly maintain water quality or preventative procedures for water can lead to issues not covered under warranty.

⚠ WARNING

Plumbing connections must comply with the applicable sanitary, safety and plumbing codes.

WATER SUPPLY GENERAL GUIDELINES ¹	
Supply Pressure (dynamic flow)	30-60 psig
Hardness	less than 3 grains (17.1 ppm = 1 grain of hardness)
Silica	less than 13 ppm
Chloramines ²	zero
Chlorides ²	less than 30 ppm ³
Total Chlorine ⁴	zero
PH	range 7-8
Undissolved Solids	less than 5 microns

¹ **Testing of water is always done AFTER water filter or water treatment used. Water quality does change with usage and should be checked after idle times to see if the condition worsens.**

² **A carbon block filter system should always be used to remove Chlorine and Chloramine. If a water softener is used, a carbon block is still required. Check with your local water treatment**

specialist for proper sizing and replacement intervals for the carbon block cartridge.

³ If the Chlorides exceed 30 ppm and the oven is used more than 8 hours during the day in steam or combination mode, the cavity will require rinsing every 8 hours. Failure to do so will result in corrosion and rusting of the oven cavity and interior parts. A Reverse Osmosis water treatment system can be installed to eliminate chlorides from the water and reduce the hardness.

Preventative washing and rinsing may be needed more than once a day to prevent compounding of contaminants inside cavity.

⁴ Total Chlorine of 4.0 ppm is the max limit for the building water supply. A carbon block filter must still be used to remove all Chlorine and Chloramines from the water. Failure to do so will result in corrosion and rust in the cooking cavity, which is not covered under warranty.

SPECIFICATIONS

Data Plate



Electrical and grounding connections must comply with the applicable portions of the National Electrical Code and / or other local electrical codes.

Supply Voltage							
Model	Phase	208V		240V		480V	
		KW	AMP	KW	AMP	KW	AMP
ABC7E	1	18	86.5	24	100	-	-
	3	18	50	24	57.8	24	28.9

Water Supply

Cold water supply with a flow pressure of 30 to 60 psi is required.

There is a 3/4" garden hose fitting located on rear of machine labeled FILTERED. This inlet must be connected to approved filter system. Failure to connect oven to approved filter system will void warranty.

There is also a 3/4" garden hose fitting located on rear of machine labeled NON-FILTER.

NOTE: Single-phase blower motors are user on these ovens, so there is no need to check direction of motor rotation. The fan will rotate in the proper direction.

Drain Connection

Drain connection must be plumbed with a minimum of 1" air gap. Drain water cannot be greater than 140°F, upon discharge. There is a 1" NPT male port for drain. Drain plumbing, not supplied, should have a constant slope towards the floor drain. Do not connect solidly to floor or other drains.

UPGRADE ABC COMBI FIRMWARE

FIRMWARE VERSION HISTORY

This section contains history of ABC7 Combi Oven Firmware. The release date of Firmware is how it is identified. The table below lists release date and a short explanation of features / fixes which were introduced with that particular version.

NOTE: Current version of firmware loaded into oven can be identified with Parameter P0 in Service Mode (1963) or Configuration Mode (1972). The current version of in-application program (IAP) shows briefly on the Timer display when USB is inserted.

Firmware Version / (Release Date)	Comments
022514 (02-25-14)	<ul style="list-style-type: none"> • First production release FIRMWARE. • IAP6.15 (in-application program) loaded to read USB port. • Rev 11 oxygen board code. • Main board identified with 'red wire' on T1, (256k flash, STM32F207VCT6, 01/14-08/16, #266-#1185).
081114 (08-11-14)	<ul style="list-style-type: none"> • IAP6.15 (in-application program) loaded to read USB port. • Rev 11 oxygen board code. • Main board identified with 'red wire' on T1, (256k flash, STM32F207VCT6, 01/14-08/16, #266-#1185). • Main board identified with 'red wire' on T1, (1024k flash, STM32F207VGT6, 10/16, #1224-#1316). <p>Serial Numbers</p> <ul style="list-style-type: none"> • 541074335 (-NAT) • 541074349 (-208V) • 541075058 (-240v) • 541074355 (-480v) <p>Combi Changes</p> <p>Fixed a motor board hardware issue with the E6 error. Motor current sense circuit would lock up and the oven sensed a "false positive" current going to the convection motor, causing an E6 motor.</p> <p>Fixed an issue with the P4, P5 and P6 custom temperature settings. It fixes an issue with the custom temps feature, in which initial lowest temp value when turning up from standby could be out of P15/16 range, if the only enabled custom temps are above/below P15/16.</p> <p>In Configuration Mode (1972), increases maximum temperature setting in parameter P15 to 482F.</p> <p>NOTE: Ovens with Serial Numbers prior to 541073334 must have their High Limit Thermostat changed before the setting of the maximum temperature can be set above 450F.</p>

Firmware Version / (Release Date)	Comments
042417 (04-24-17)	<ul style="list-style-type: none"> • IAP6.21 (in-application program) loaded to read USB port with Rev 12 oxygen board code. • Main Board identified with 'green wire' on T1, (1024k flash, STM32F207VGT6, 01/17+, #1317+). • Oxygen Sensor, Revision C, August 2016. <p>Starting Serial numbers FIRMWARE</p> <ul style="list-style-type: none"> • 541083050 (-NATP) or 541083053 (-208P, -240P, -480P) • 541083068 (-NAT) or 541083068 (-208, -240, -480) <p>Backward Compatibility</p> <p>The 4-24-17 firmware is backward compatible to ovens with 8-11-14 or 2-25-14. It is highly recommended that the upgrade to IAP 6.21 and Rev 12 oxygen board software be completed at the same time. However, if the IAP and oxy boards are not also upgraded, the oven will still work but without benefit of the E14 and E28 diagnostics and new functionality thereof.</p> <p>IAP Changes</p> <p>Work-around for damaged USB port on Main board. If proper operation of USB port on main board is not properly detected in 1 second, the USB port is ignored. Fixed rare issue with USB_HOST_CONN shown on display interrupting normal oven operation. Pairs with Combi firmware addition of E14 error.</p> <p>Combi Changes</p> <ul style="list-style-type: none"> • Changed Service Test Mode (1963). <ul style="list-style-type: none"> • Added additional oxygen sensor tests: o5, o6, o7, Pb. • Added error codes: E14 (USB-requires IAP 6.21), E21 (motor speed), E29 (rtd). • Removed error code E16 removed & replaced with E22, E23, E24, E25, E26, E27, E28 (E28 Requires Revision 12 oxygen board firmware). • Changed Configuration Mode (1972). <ul style="list-style-type: none"> • Changed P12 (motor speed). Added P21 (probe calibration), P29 (cook 2 probe UI), P34 (humidification method). • Changed defaults P25 and P26 for drain water tempering for new style drain with bent tube assembly, current production for starting s/n's: <ul style="list-style-type: none"> 541082447 (-NAT) OR 541082442 (-208) 541082482 (-240) 541082425 (-480) • Added P76 (factory only) to calibrate TC1 & TC2 thermocouple based on TC2 external meat probe thermocouple analog offset (after 2-minute temperature stabilization). Turning Timer knob switches Timer display to show uncalibrated probe temp (TC2 with P76 analog offset applied) for ease of calibration. • Changed User Interface.

Firmware Version / (Release Date)	Comments
	<ul style="list-style-type: none"> • Additional functionality of Cook-to-Probe and Fan Speed Control with push button encoder. Added fan speed to the time and humidity “recalled” settings when the on/off switch is turned on. (If oven is equipped: ABCx-xxxP devices only. Pairs with P29, P12, P21.) • Changed Operate Mode. <ul style="list-style-type: none"> • Removed the temperature augmentation to 220F, at temperature setpoints of 212-220F for enhanced steaming. • Removed sensor based valve/vent operation at the 100% humidity setpoint case and replaced with continual flow of Y9 low hum water valve while vent remains closed. Defaults to sensor based humidification at humidity setpoints of <100%. Pairs with configuration setting P34 (default=dis) for enhanced steaming. • Modified transfer function and calculations for additional accuracy on TC2 thermocouple reading for the cook-to-probe feature. Applies to all thermocouples. Pairs with Main board hardware modifications to the probe circuit as indicated by the “green” wire on T1. • Removed all audible “error beeps” for all non-critical errors. • Fixed a rare issue with the timer expiring/alarming when not previously set. Or which “no” or “HEAT” could show for a split second after closing the door. • General Fixes: <ul style="list-style-type: none"> • Change project target was STM32F207IGH6, 1M flash, now STM32F207VGT6, 1M flash corresponds to hardware change on Main board. • Update to stm32 2.28 support package. Double the heap and stack size. (Software maintenance.)

FIRMWARE UPDATE PROCEDURE

1. Obtain a copy of ABCombi.bin file and the IAP.bin file from the Hobart Service Resource Center and load it onto a USB flash drive (thumb drive).

NOTE: The file must be loaded in the root directory in the USB flash drive.

2. Remove RIGHT PANEL.
3. Re-apply power to oven and ensure door is closed.
4. Review and record oven's unique information.

NOTE: The oven's internal memory is reconfigured, and set to factory default when updating from 8-11-14 to 4-24-17. It is necessary to record any unique information.

- A. Write down any custom settings in Configuration Mode (1972) Parameters P4, P5, P6. These settings must be re-configured after firmware update.

- B. Review (or Error Download to USB Flash Drive) the Error Log and Counter data in 1963 Service Test Mode for your records or analysis.

NOTE: Oven memory will not be overwritten when upgrading from 4-24-17 to future revisions.

5. Place the Oven in Idle Mode (Temperature display - - -).
 - No Set Temperature.
 - Not in service test mode (1963).
 - Not in configuration mode (1972).
6. Insert the USB flash drive into the oven's USB-A port.

NOTE: The convection fan motor may or may not come on when the USB flash drive is inserted.

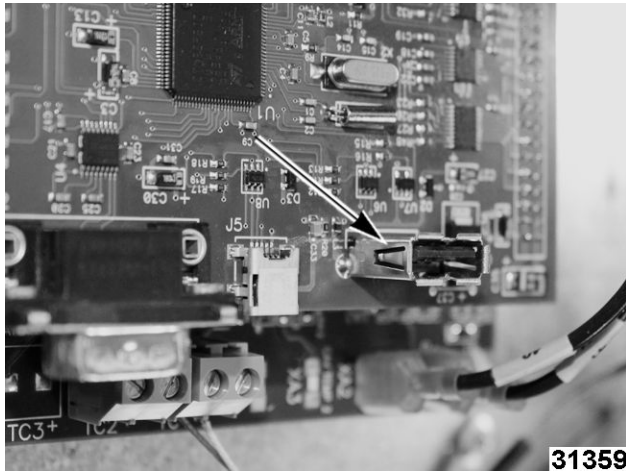

Fig. 4

7. View the LED displays on the front of the oven.
 - The oven briefly flashes the in-application program version IAP 6.21 on the timer display.
8. "Usb Flsh n_y" appears on the display.
 - If something other than "Usb Flsh n_y" is displayed, then refer to USB ERROR MESSAGES.
 - If "n" is selected with the humidity knob (turned to the left, ccw), the oven will return to Idle mode. Firmware not updated.
 - If "y" is selected (turned to the right, cw), the humidity display briefly changes to show "yes", then "del" as the necessary flash is deleted, then begins showing a percentage complete from 0-100 as the software image is flashed. When flashing is complete (usually after a few seconds), the humidity display briefly shows "don", which indicates the software flashed correctly. Oven returns to the Idle Mode (Temperature display ---). Firmware is updated.
9. Enter Configuration Mode (1972),
 - Verify that parameter P0 now shows 4-24-17 as the firmware revision code.
 - Enter oven hour count, found in parameter P18 on the service ticket.
10. Update the In-Application Program (IAP).

NOTE: Updating the IAP is highly recommended when updating firmware from 8-11-14 to 4-24-17 or later versions. Required for proper operation of the E14 error and "USB HOST Conn" fix.

NOTE: When updating firmware from 4-24-17 to later versions skip to step 11.

- A. Continue in configuration mode (1972), with the USB flash drive remaining inserted.
- B. Turn temperature knob clockwise to P72. "2000" shows on timer display.
- C. Turn timer knob counterclockwise to enter password "1972" allowing access. "Eng" shows on timer display.
- D. Turn temperature knob counterclockwise to P65. Display will show "FIAP no".
- E. Turn humidity knob clockwise to select "yes" to request IAP firmware update. Display will show "IAP FLSH n_y".

NOTE: If oven does not respond, select "yes" again.

- F. Turn humidity knob counterclockwise to select "y" and initiate IAP download. Selecting "n" will cancel back to P65.
 - Display will show "USb flsh don".
 - Display will briefly show "IAP 6.21" (watch for this to verify the IAP updated correctly).
 - Display will show "IAP FLSH n_y", asking to re-flash the oven firmware (not IAP firmware) again. Select "n", but you can select either "y" or "n" without issue.
 - Oven exits configuration mode, and returns to Idle Mode (Temperature display ---).

11. Remove USB flash drive.

Updating the Oxygen Sensor Board Firmware

Oxygen sensor board firmware cannot be updated remotely and must be replaced to get the current revision. Contact your local Hobart Service office for the latest replacement part.

USB ERROR MESSAGES

Error Message	Corrective Action
Usb Host Con or Usb Host Enu	Remove USB drive. When temperature display returns to "---", reinsert USB drive.
Usb No Fil:	The ABCCombi.bin file was not found on USB drive. Reload ABCCombi.bin file.
USB Fail < 1, 2 or 3 >	USB drive needs to be formatted in FAT32 format. If this fails use a different USB drive.
USB Fail < 4-5, 7-8 or 15-18 >	Remove USB drive. When temperature display returns to "---", reinsert USB drive. If error persists, use a different USB drive.
USB Fail < 9-14>	Remove USB drive. When temperature display returns to "---", reinsert USB drive. If error persist, replace Main Control Board

REMOVAL AND REPLACEMENT OF PARTS

PANELS



WARNING

Disconnect the electrical power to the machine and follow lockout / tagout procedures.

Right Panel

1. Remove four right panel screws.
2. Lift right panel up and back using handles.

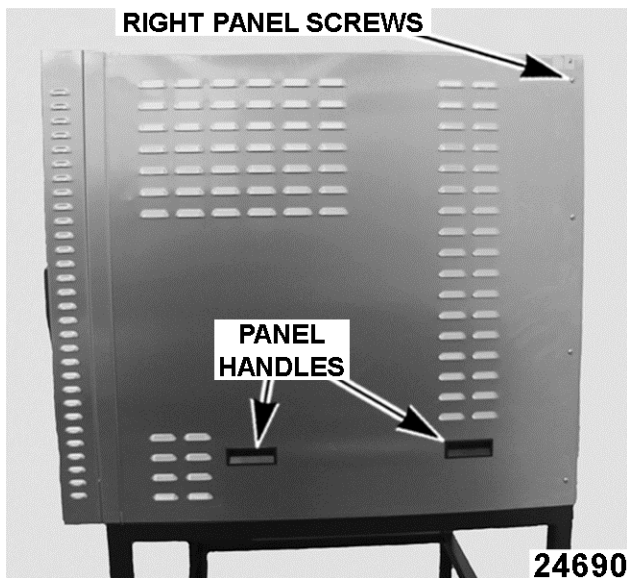

Fig. 5

3. Reverse procedure to install.

Rear Panel

1. Remove RIGHT PANEL.
2. Remove two fan screws (1, Fig. 6).
3. Remove six utility panel screws (2, Fig. 6).

NOTE: Bottom two utility screws only support utility panel and can be left assembled.

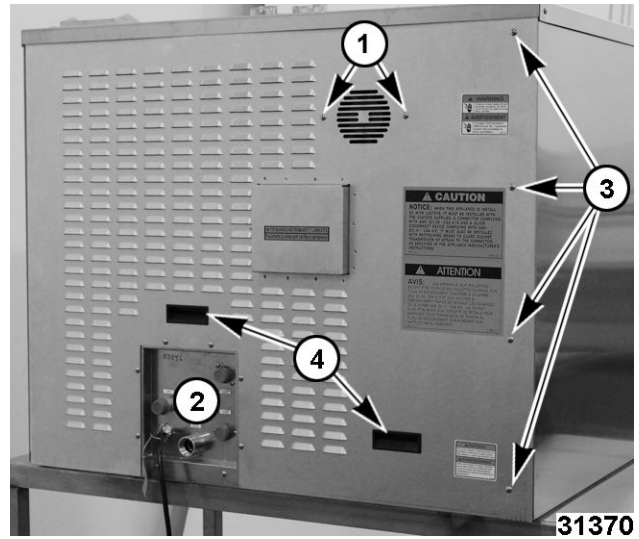

Fig. 6

4. Remove screw in the upper right hand corner on right side of oven.

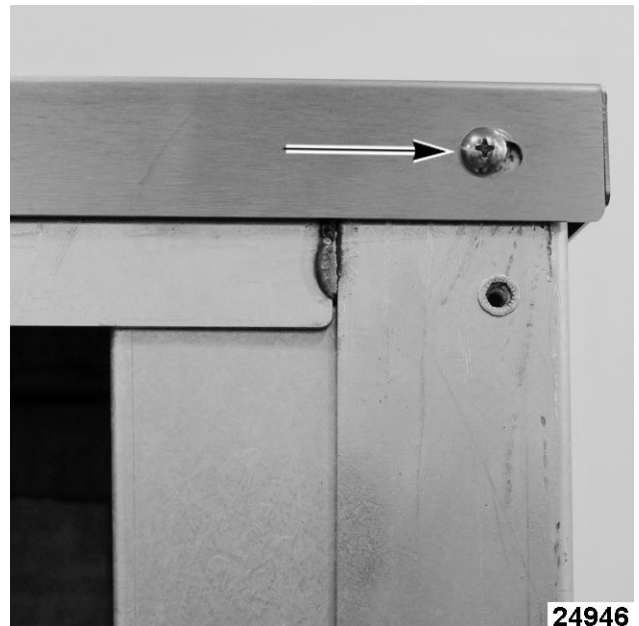

Fig. 7

5. Remove four rear panel screws (3, Fig. 6).

NOTE: Hold onto one panel handle to prevent rear panel from falling.

6. Lift with handles (4, Fig. 6) to remove.
7. Reverse procedure to install.

Left Panel

1. Remove RIGHT PANEL.
2. Remove REAR PANEL.

- Remove screw in the upper left hand corner on left side of oven.
- Lift left panel up and back towards the rear of unit.

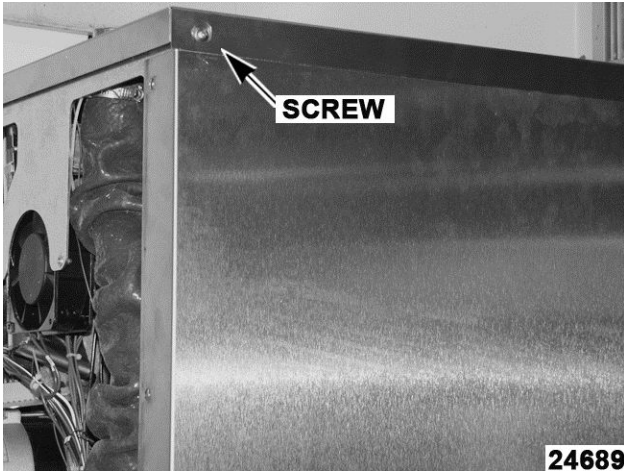

Fig. 8

- Reverse procedure to install.

INNER DOOR

- Open oven door.
- Unlatch inner door using inner door latch.

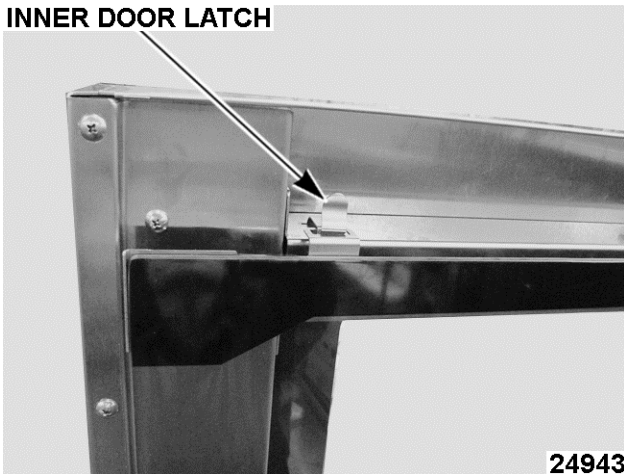

Fig. 9

- Lift inner door up off door hinge.

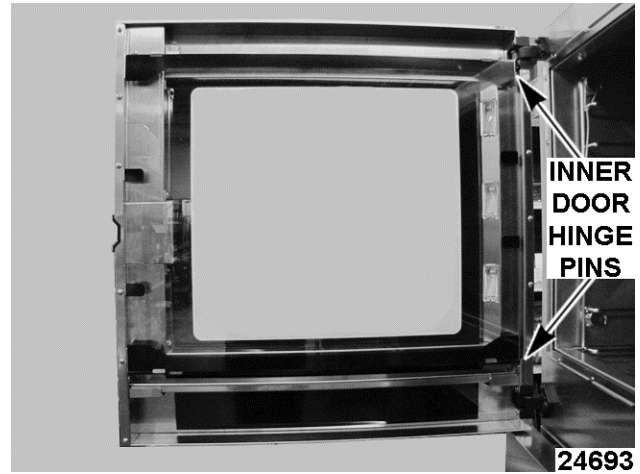

Fig. 10

- Place inner door in a secure location to prevent damage.
- Reverse procedure to install.

DOOR LAMP



WARNING

Disconnect the electrical power to the machine and follow lockout / tagout procedures.

NOTE: Previous production ovens had three 5W lamps. Current production ovens have one 10W lamp.

- Remove INNER DOOR.
- Insert screwdriver in slot just above screw.

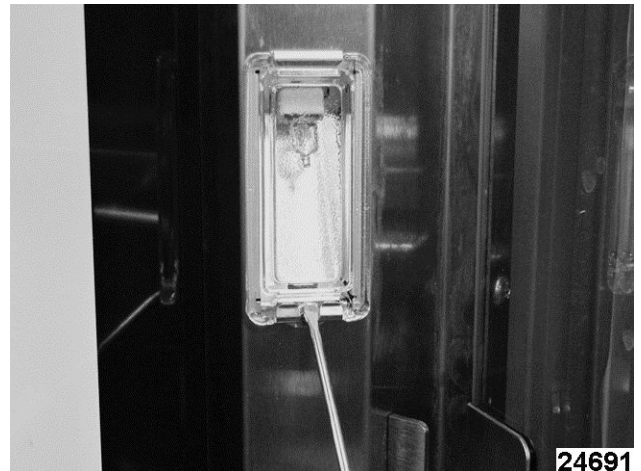

Fig. 11

- Push in tab to free glass cover from lamp holder.
- Grasp lamp using cloth and remove from lamp socket.

NOTICE

Do not touch Halogen lamp with bare hands. If lamp is exposed to oil from skin, life of the Halogen lamp will be reduced. Skin oil may be removed with alcohol while lamp is cold.

NOTE: Use a clean rag or paper towel to handle replacement lamp. Ensure lamp is free from oil and dirt before replacing.

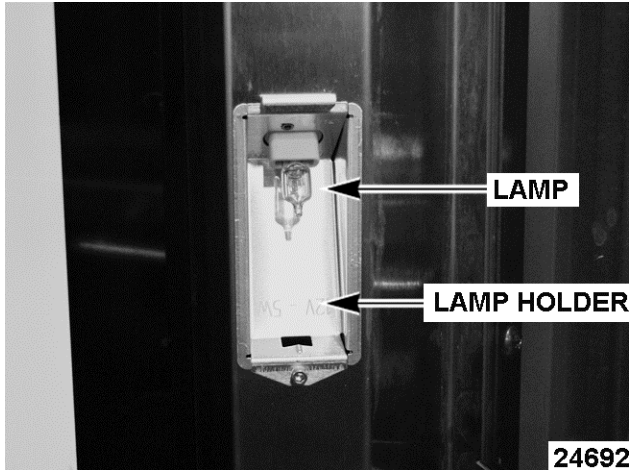

Fig. 12

- Reverse procedure to install.

DOOR LATCH

WARNING

The oven and its parts are hot. Use care when operating, cleaning or servicing the oven. The cooking compartment contains live steam. Stay clear when opening door.

Door Cam

- Open door and remove INNER DOOR.
- Remove door lock cover.



Fig. 13

- Remove cam screw (1, Fig. 14) and washer.

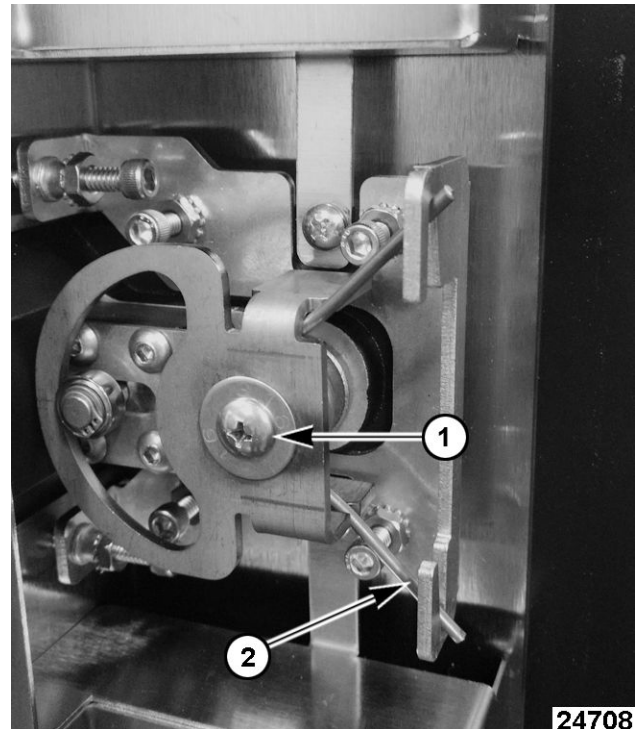

Fig. 14

- Release torsion spring from lower slot (2, Fig. 14) in clamp bracket, then release top spring.
- Press latch (1, Fig. 15) into door to remove cam (2, Fig. 15).

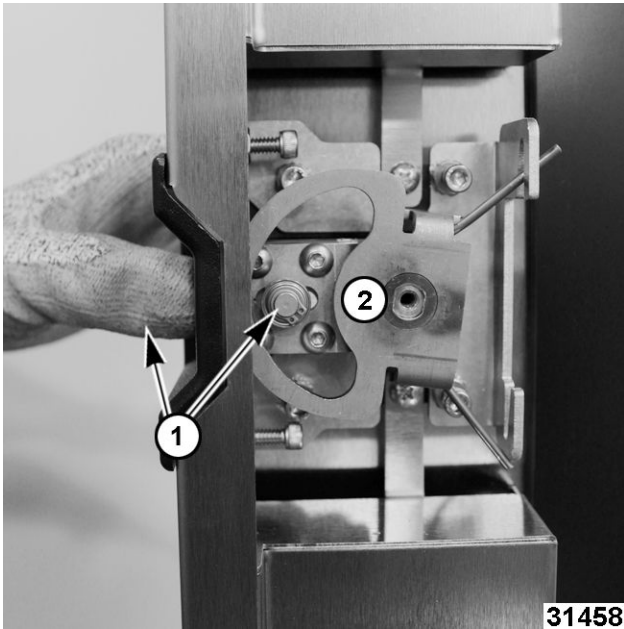

Fig. 15

Latch Assembly

1. Remove DOOR CAM.
2. Remove four allen screws (1-4 in Fig. 16) on plunger mechanism.

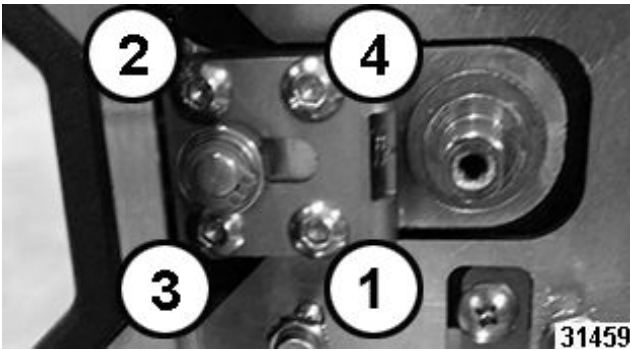

Fig. 16

3. Reverse procedure to install.

NOTE: When installing new plunger, tighten allen screws in crisscross pattern as numbered in Fig. 16 and torque to 24 in. lbs.

4. Check for proper operation.

DOOR SWITCH



WARNING

Disconnect the electrical power to the machine and follow lockout / tagout procedures.

1. Remove CONTROL PANEL.

NOTICE

Do not place control panel on knobs. Doing so will damage encoders. Lift one side of control panel up to prevent knobs from touching surface.

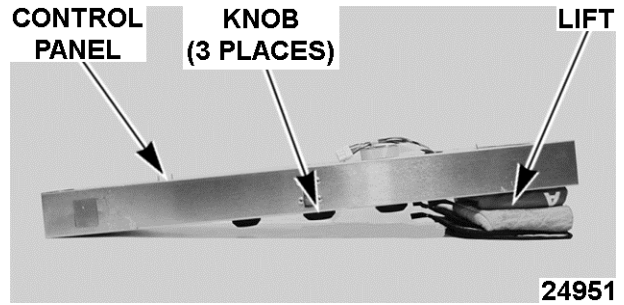

Fig. 17

2. Remove back control panel.
3. Remove two lock nuts (1, Fig. 18).

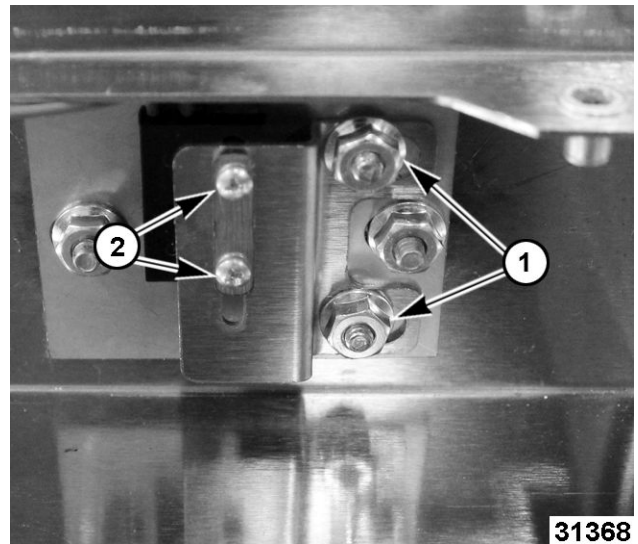

Fig. 18

4. Remove two screws (2, Fig. 18) to release switch from bracket.
5. Insert screwdriver into switch wire connector and push down on lower side to release wires.

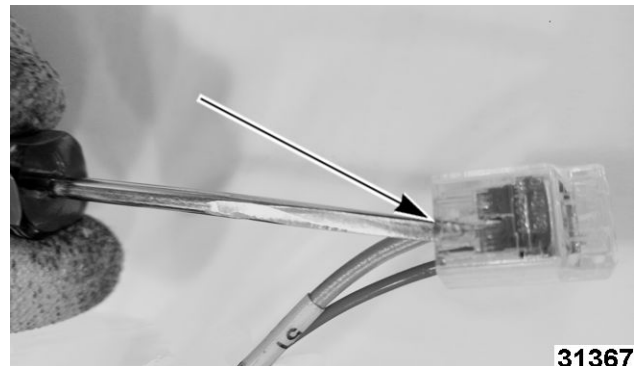

Fig. 19

6. Reconnect wires to connector.
7. Install switch into bracket. Must measure 3 1/2" from bottom of control box and 1-3/16" as shown in Fig. 20.

NOTICE

Measurements for switch placement are critical to door switch operation.

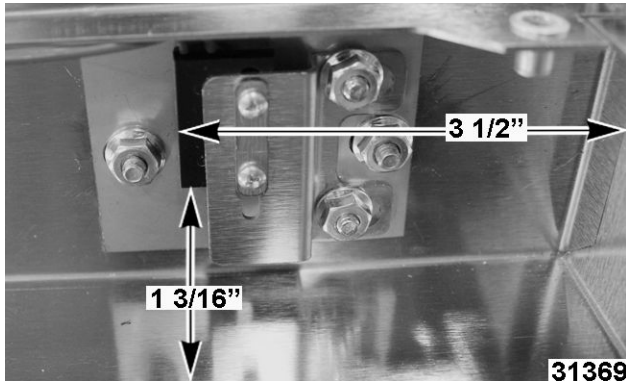

Fig. 20

8. Install control panel back cover.
9. Install control panel to oven.

NOTICE

The door operation (latch, handle and sealing) can be negatively affected any time the control panel has been moved for servicing. Verify door latch alignment with door by opening and closing door when Control Panel is loosely mounted AND when securely mounted. If door is not operational, perform DOOR TO CONTROL PANEL ALIGNMENT.

10. Verify door switch operation.

DOOR SEAL

Refer to TIS Video in Multimedia: ABC Combi Door Seal Replacement

MAIN CONTROL BOARD

NOTICE

Certain components in this system are subject to damage by electrostatic discharge (ESD) during field repairs. An ESD kit is required to prevent damage. The ESD kit must be used anytime the circuit board is handled.

1. Check CONFIGURATION MODE (1972) ELECTRIC for customer's current parameter settings. **Document customer's parameter settings.**

NOTE: This step can only be accomplished if main control board is still operational.

NOTE: Oven hour counter (P18), water counter values (P19, P20), and error log will start new, with replacement main control board.



WARNING

Disconnect the electrical power to the machine and follow lockout / tagout procedures.

2. Remove RIGHT PANEL.
3. Note and disconnect electrical connections from main control board and oxygen sensor board.
4. Squeeze nylon standoffs to release and remove main control board.

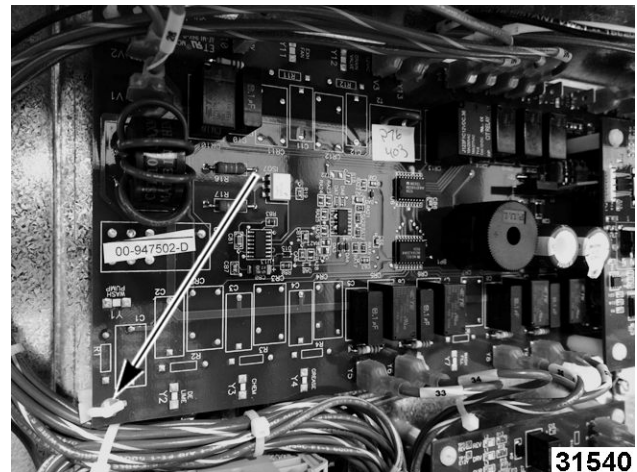

Fig. 21

5. Remove OXYGEN SENSOR BOARD from main control board.

Installation of Replacement Control Board

1. Install OXYGEN SENSOR BOARD onto replacement main control board.

NOTE: Oxygen sensor board is easier to install onto main control board before installing main control board.

2. Line up holes on new main control board with nylon standoffs (x10).
3. Press board onto standoffs.
4. Follow diagram MAIN CONTROL BOARD CONNECTIONS to rewire replacement board.
5. Configure board to customer's preferred parameter settings for P25, P26, and P29 in configuration version. Refer to CONFIGURATION MODE (1972) ELECTRIC for configuration settings.

6. Refer to: CALIBRATING OXYGEN SENSOR BOARD if oxygen board is being replaced.
7. Check for proper operation.

OXYGEN SENSOR



⚠ WARNING

Disconnect the electrical power to the machine and follow lockout / tagout procedures.

⚠ WARNING

Oxygen sensor is very HOT. Use care when servicing oxygen sensor.

NOTE: Remove power from unit before replacing oxygen sensor. Having power to board when installing sensor will cause damage oxygen sensor.

NOTE: Sensor can be damaged by water. Do not get it wet.

1. Remove RIGHT PANEL.
2. Remove REAR PANEL.
3. Disconnect main board TC cable plug (1, Fig. 22) from oxygen sensor cable at plug (2, Fig. 22).

NOTE: Do NOT disconnect cable from Oxygen Sensor Board.

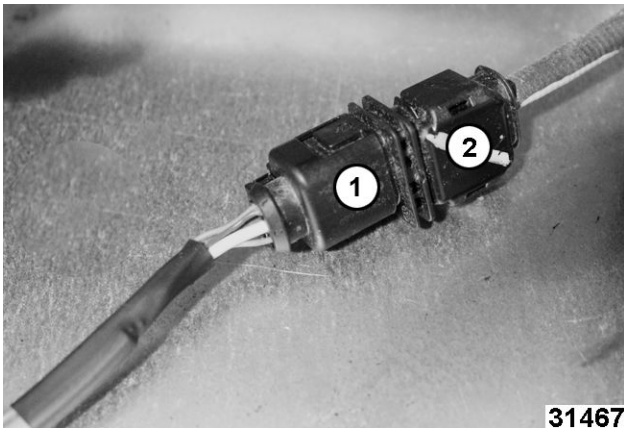

Fig. 22

⚠ WARNING

Allow oxygen sensor to cool completely before removing. Sensor, when powered and operating, is very HOT.

4. Remove all wire ties from oxygen sensor cable.
5. After oxygen sensor has cooled, loosen hex and carefully remove sensor from fitting.

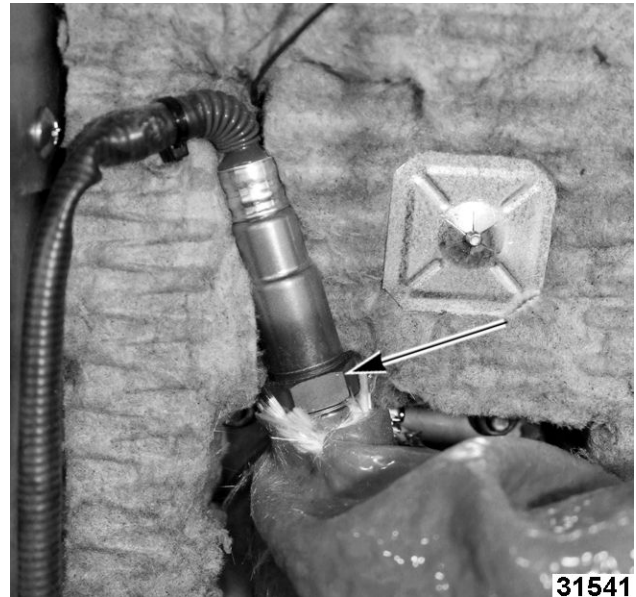

Fig. 23

6. Reverse procedures to install.
7. When installing, route oxygen sensor cable as previously installed.

NOTE: Inspect oxygen sensor extension cable for damage and replace if necessary.

NOTICE

Oxygen sensor cables are sensitive to electrical noise and must be routed away from other wires.

8. Power unit on.
9. Check for proper operation.

OXYGEN SENSOR BOARD



⚠ WARNING

Disconnect the electrical power to the machine and follow lockout / tagout procedures.

NOTICE

Certain components in this system are subject to damage by electrostatic discharge (ESD) during field repairs. An ESD kit is required to prevent damage. The ESD kit must be used anytime the circuit board is handled.

1. Remove RIGHT PANEL.
2. Note wires and remove connections from oxygen sensor board.

- Remove oxygen sensor board screws. Retain screws for installation of replacement oxygen sensor board.

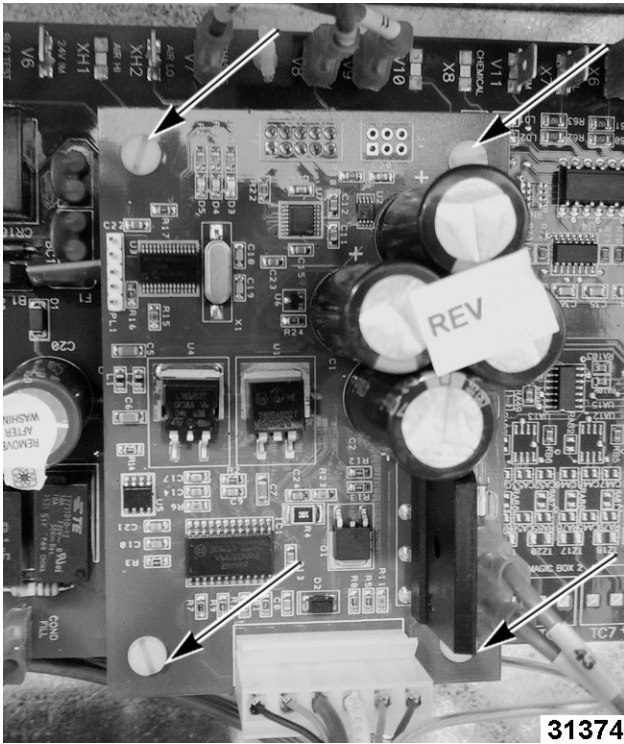

Fig. 24

NOTICE

Oxygen sensor board must be installed while unit is **unplugged**. Failure to install while unit is **unplugged** will cause permanent damage to oxygen sensor board.

Installation of Oxygen Sensor Board.

- Verify oxygen sensor board holes line up with the main control board standoffs.

NOTICE

Verify electrical connection between main board and oxygen board is secure by connecting 10-pin female header on back side of oxygen board to 10-pin male header located on main control board.

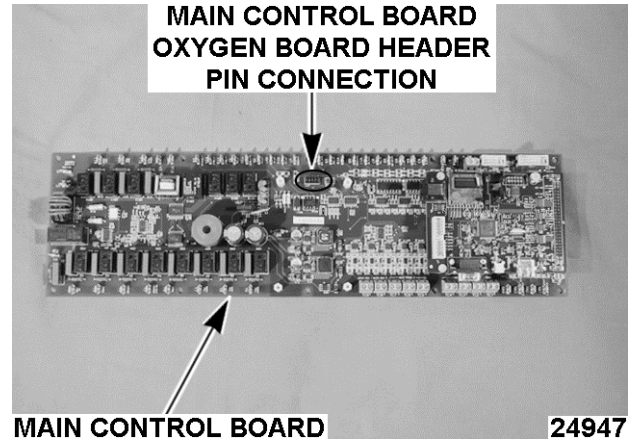

Fig. 25

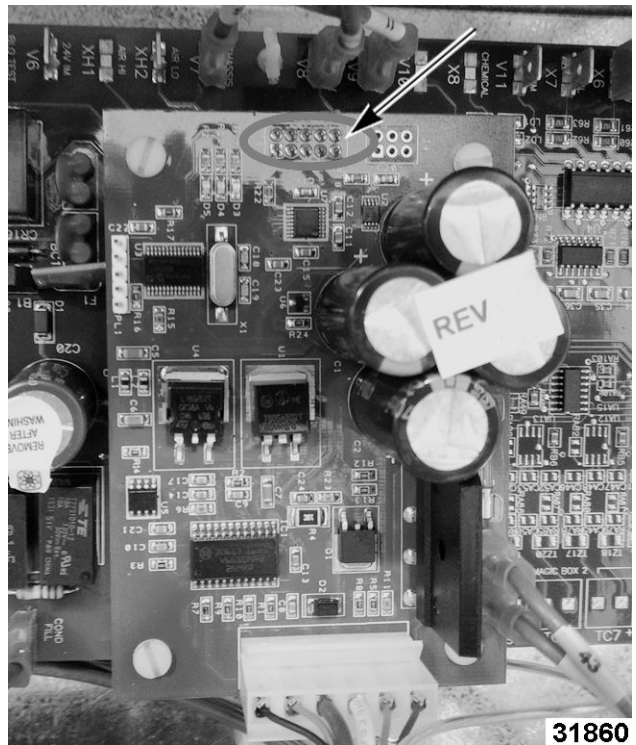

Fig. 26

- Secure using screws from replaced board.
- Power on unit.
- CALIBRATING OXYGEN SENSOR BOARD.
- Check for proper operation.

NOTICE

Refer to SERVICE MODE (1963), and perform oxygen sensor test o1 through o5.

FERRITE



WARNING

Disconnect the electrical power to the machine and follow lockout / tagout procedures.

1. Remove RIGHT PANEL.
2. Lift ferrite clip with flat screw driver (two places).

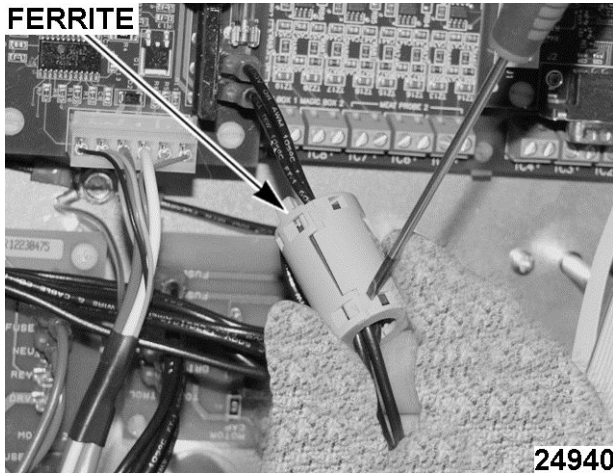

Fig. 27

3. Reverse procedures to install.

NOTE: Install ferrite approximately three inches from oxygen sensor board.

NOTE: Loop ferrite wires around the ferrite to keep ferrite in place.

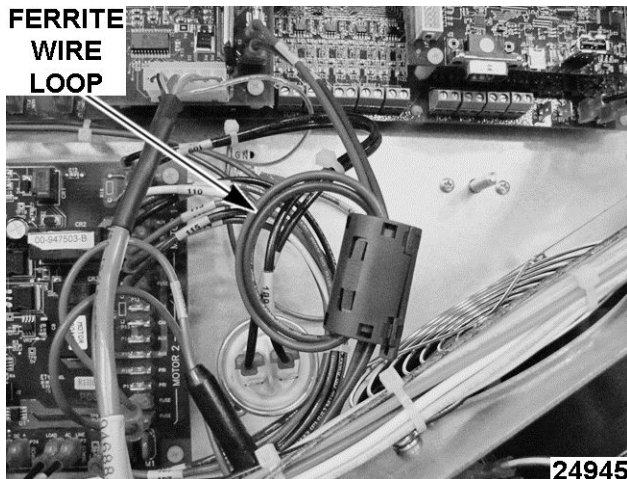

Fig. 28

MOTOR CONTROL BOARD



WARNING

Disconnect the electrical power to the machine and follow lockout / tagout procedures.

NOTICE

Certain components in this system are subject to damage by electrostatic discharge (ESD) during field repairs. An ESD kit is required to prevent damage. The ESD kit must be used anytime the circuit board is handled.

1. Remove RIGHT PANEL.
2. Note and disconnect electrical connections from board.
3. Remove motor control board nylon screws.

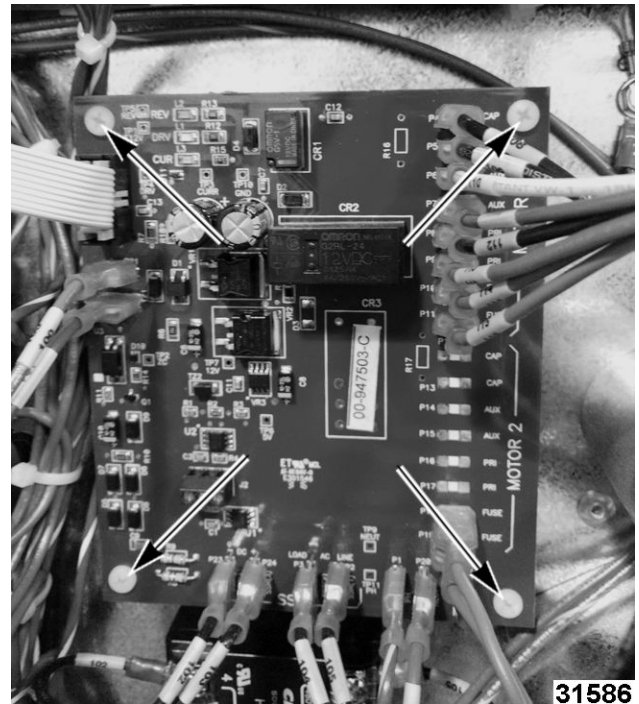

Fig. 29

4. Reverse procedure to install.
5. Check for proper operation.

CONTROL BOX COOLING FAN



⚠ WARNING

Disconnect the electrical power to the machine and follow lockout / tagout procedures.

1. Remove RIGHT PANEL.
2. Unplug two wires going to fan.
3. Remove two screws securing fan to frame.
4. Reverse procedure to install.
5. Check for proper air flow.

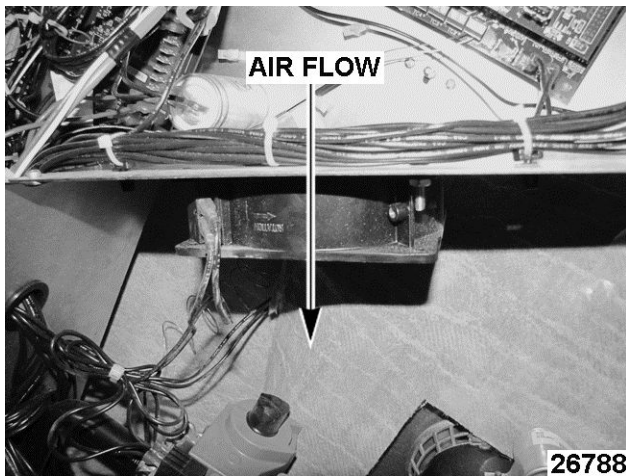

Fig. 30

CONTROL PANEL



⚠ WARNING

Disconnect the electrical power to the machine and follow lockout / tagout procedures.

NOTICE

Certain components in this system are subject to damage by electrostatic discharge (ESD) during field repairs. An ESD kit is required to prevent damage. The ESD kit must be used anytime the circuit board is handled.

Control Panel

1. Remove RIGHT PANEL.
2. Disconnect **P1** connector.



Fig. 31

3. Disconnect motor and control board ribbon cables.

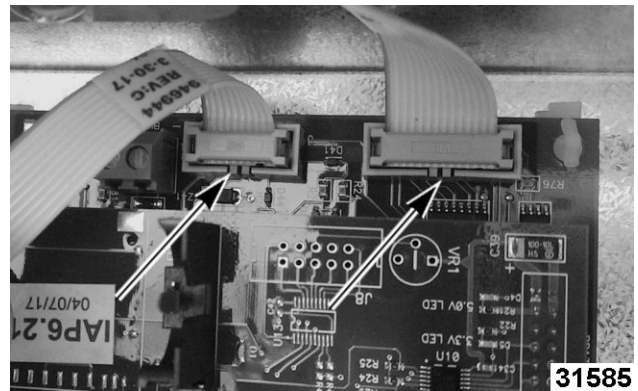

Fig. 32

4. Remove ribbon cable wire ties.

NOTE: Replace wire ties on install.



Fig. 33

5. Secure panel while removing six recessed control panel screws.

⚠ WARNING

Control panel could fall out of place as soon as screws are removed.

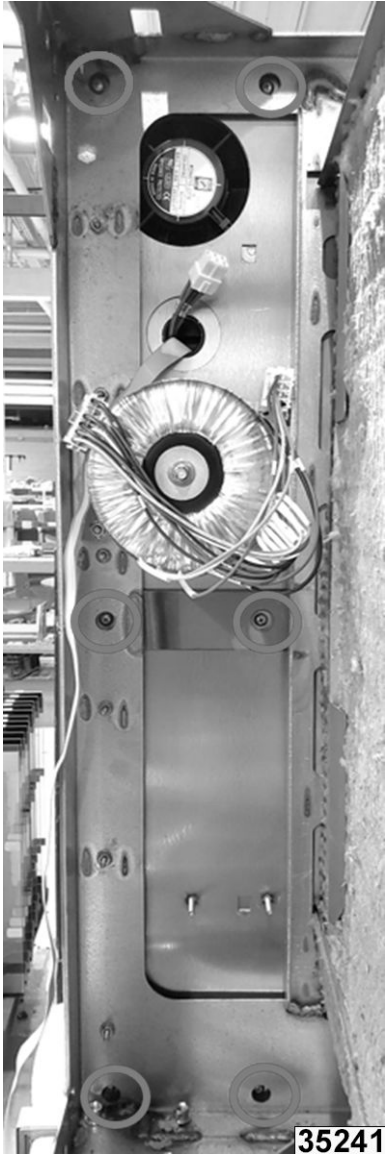

Fig. 34

6. Lift control panel up off hooks.

NOTE: Carefully pull connector and ribbon cable through hole when removing control panel.



Fig. 35

7. Place control panel on a clean, flat surface.
8. Place in secure location.

NOTICE

Do NOT place control panel flat on knobs. Doing so will cause damage to encoders.

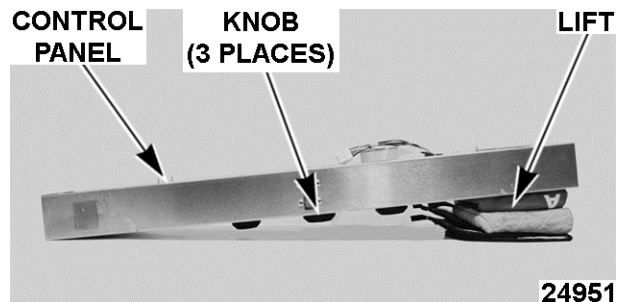

Fig. 36

9. Reverse procedures to install.

NOTICE

The door operation (latch, handle and sealing) can be negatively affected any time the control panel has been moved for servicing. Verify door latch alignment with door by opening and closing door when Control Panel is loosely mounted **AND** when securely mounted. If door is not operational, perform DOOR TO CONTROL PANEL ALIGNMENT.

NOTE: Motor control board ribbon cable will fit in J1 as well as J8, verify it is plugged into J1 on Main board.

10. Verify proper operation.

CONTROL PANEL COOLING FAN



WARNING

Disconnect the electrical power to the machine and follow lockout / tagout procedures.

NOTICE

Certain components in this system are subject to damage by electrostatic discharge (ESD) during field repairs. An ESD kit is required to prevent damage. The ESD kit must be used anytime the circuit board is handled.

Display Board Fan

1. Remove CONTROL PANEL from unit.
2. Place control panel in a secure location.
3. Remove screws from back of control base panel.

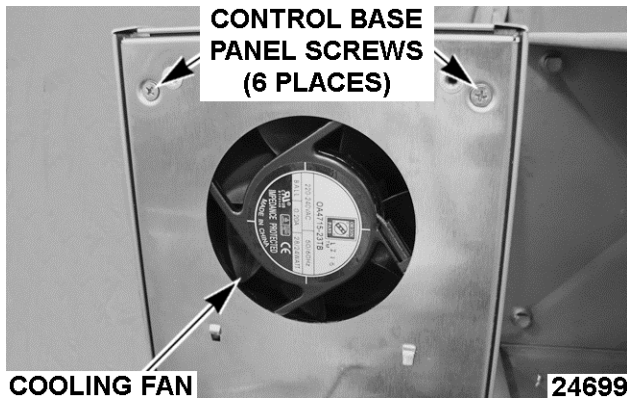

Fig. 37

4. Disconnect cooling fan wire connection.
5. Remove cooling fan nuts.

Previous Production Shown

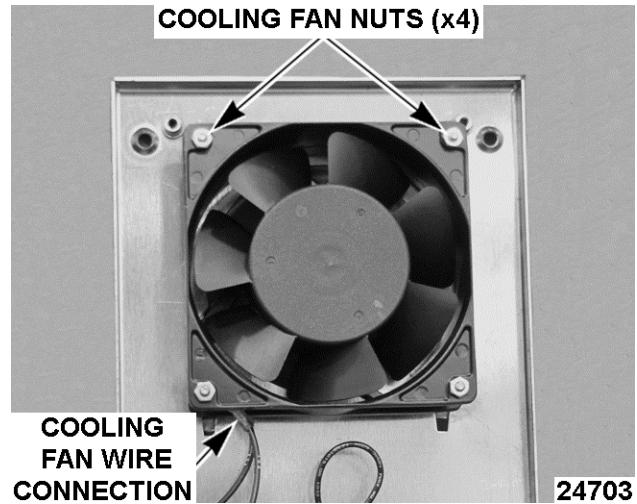

Fig. 38

6. Verify arrows are facing the correct direction when installed.

NOTE: Air to exhaust out of control panel.

Previous Production Shown

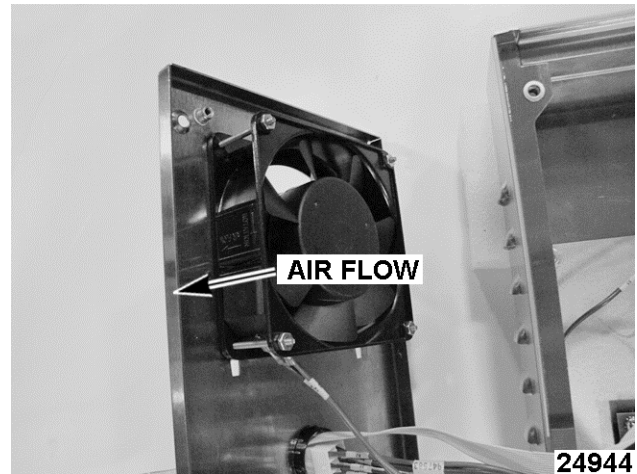

Fig. 39

7. Reverse procedure to install.
8. Check for proper operation.

NOTICE

The door operation (latch, handle and sealing) can be negatively affected any time the control panel has been moved for servicing. Verify door latch alignment with door by opening and closing door when Control Panel is loosely mounted **AND** when securely mounted. If door is not operational, perform DOOR TO CONTROL PANEL ALIGNMENT.

ON / OFF SWITCH



⚠ WARNING

Disconnect the electrical power to the machine and follow lockout / tagout procedures.

On / Off Switch

1. Remove CONTROL PANEL from unit.
2. Remove screws from back of control base panel.



Fig. 40

NOTE: Use care when removing back of control panel cover. Wires are attached.

NOTICE

Certain components in this system are subject to damage by electrostatic discharge (ESD) during field repairs. An ESD kit is required to prevent damage. The ESD kit must be used anytime the circuit board is handled.

3. Disconnect On/Off switch wires.

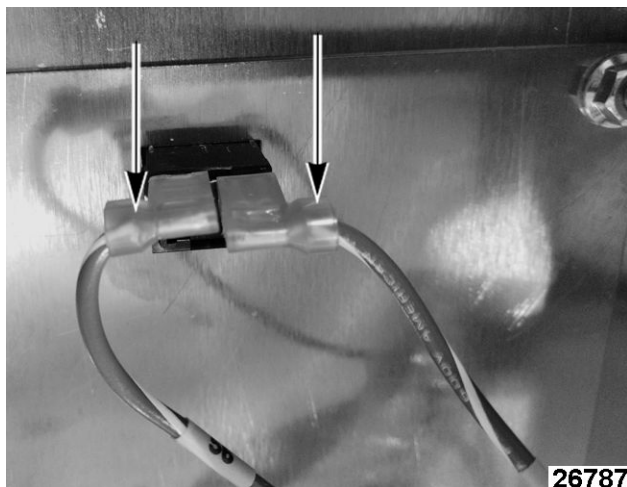

Fig. 41

4. Using a pair of channel locks, squeeze in the sides and press the switch out the front of the panel.
5. Reverse procedures to install.

NOTICE

The door operation (latch, handle and sealing) can be negatively affected any time the control panel has been moved for servicing. Verify door latch alignment with door by opening and closing door when Control Panel is loosely mounted **AND** when securely mounted. If door is not operational, perform DOOR TO CONTROL PANEL ALIGNMENT.

6. Check for proper operation.

KNOB & ENCODER



⚠ WARNING

Disconnect the electrical power to the machine and follow lockout / tagout procedures.

NOTICE

Certain components in this system are subject to damage by electrostatic discharge (ESD) during field repairs. An ESD kit is required to prevent damage. The ESD kit must be used anytime the circuit board is handled.

Control Knob & Encoder

1. Remove CONTROL PANEL.
2. Place control panel in a secure location.
3. Disconnect encoder ribbon cables.

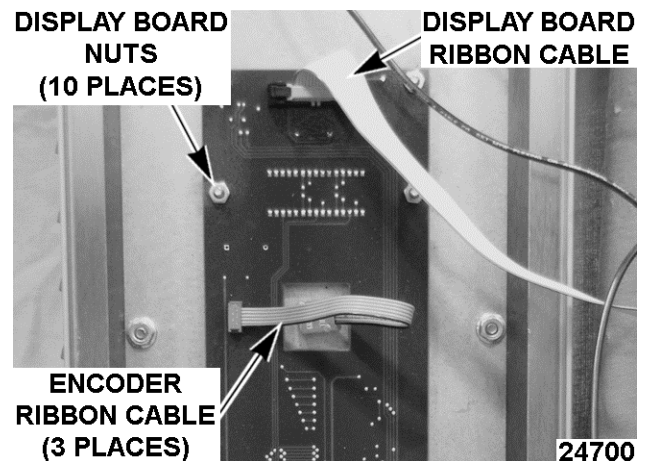

Fig. 42

4. Loosen set screw (1, Fig. 43) in tapped hole on knob.

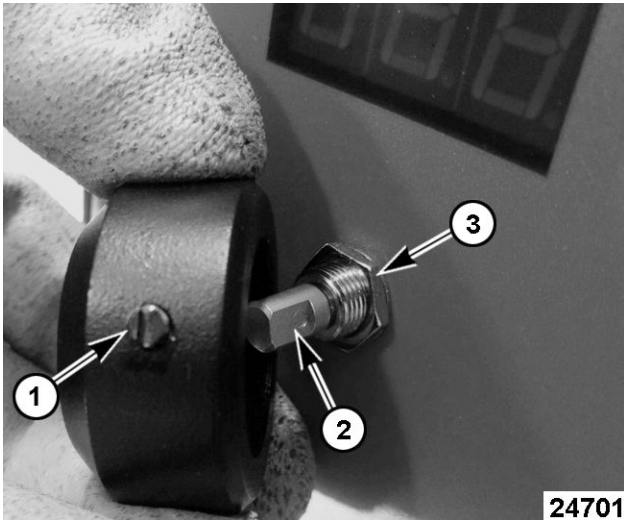

Fig. 43

5. Remove encoder nut (3, Fig. 43) to remove encoder.
6. Reverse procedures to install.

NOTE: Tapped hole needs to be aligned with flat part (2, Fig. 43) of encoder. Align tab in control panel hole needs to align with groove in encoder.

7. Check for proper operation.

NOTICE

The door operation (latch, handle and sealing) can be negatively affected any time the control panel has been moved for servicing. Verify door latch alignment with door by opening and closing door when Control Panel is loosely mounted **AND** when securely mounted. If door is not operational, perform DOOR TO CONTROL PANEL ALIGNMENT.

NOTE: Verify push button feature (ABCx-xxxxP devices only) is operable after knob is installed.

DISPLAY BOARD



WARNING

Disconnect the electrical power to the machine and follow lockout / tagout procedures.

NOTICE

Certain components in this system are subject to damage by electrostatic discharge (ESD) during field repairs. An ESD kit is required to prevent damage. The ESD kit must be used anytime the circuit board is handled.

Display Board

1. Remove CONTROL PANEL from unit.
2. Remove screws from back of control base panel.

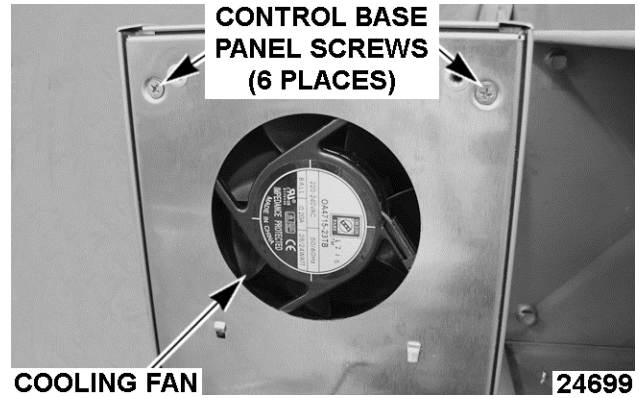

Fig. 44

NOTE: Use care when removing back of control panel cover. Wires are attached.

NOTICE

Certain components in this system are subject to damage by electrostatic discharge (ESD) during field repairs. An ESD kit is required to prevent damage. The ESD kit must be used anytime the circuit board is handled.

3. Remove display board ribbon cable.
4. Remove encoder ribbon cables.
5. Remove display board nuts.

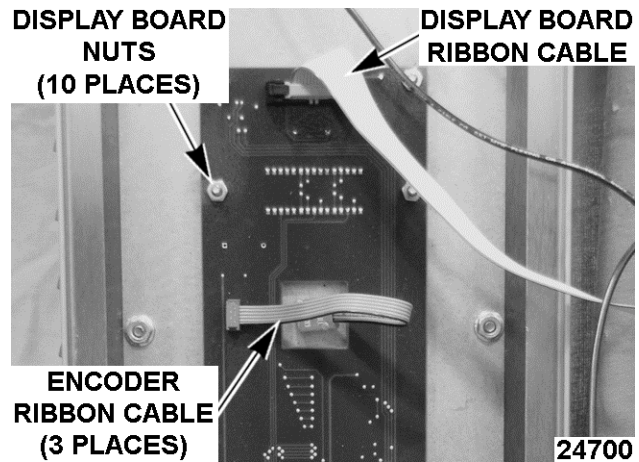

Fig. 45

6. On the new display board, make sure that jumper J5 on the back of the display board is installed and on the correct two pins. (The two closest to the edge of the board.)

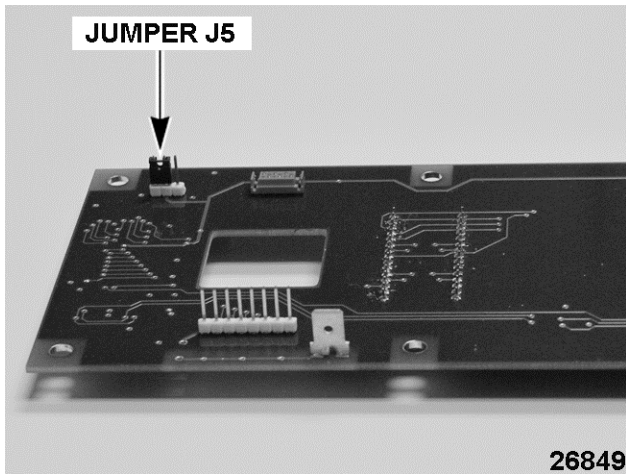

Fig. 46

7. Reverse procedures to install.
8. Check for proper operation.

NOTICE

The door operation (latch, handle and sealing) can be negatively affected any time the control panel has been moved for servicing. Verify door latch alignment with door by opening and closing door when Control Panel is loosely mounted **AND** when securely mounted. If door is not operational, perform DOOR TO CONTROL PANEL ALIGNMENT.

MEAT PROBE SOCKET



WARNING

Disconnect the electrical power to the machine and follow lockout / tagout procedures.

1. Remove RIGHT SIDE PANEL.
2. Disconnect probe socket from control board at TC2 connection (1, Fig. 47).

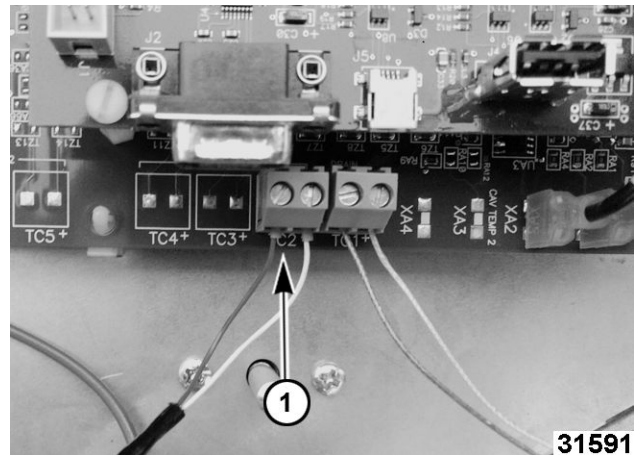

Fig. 47

3. Remove CONTROL PANEL.
4. Remove screws (1, Fig. 48), nuts (from behind), and probe socket from control panel.

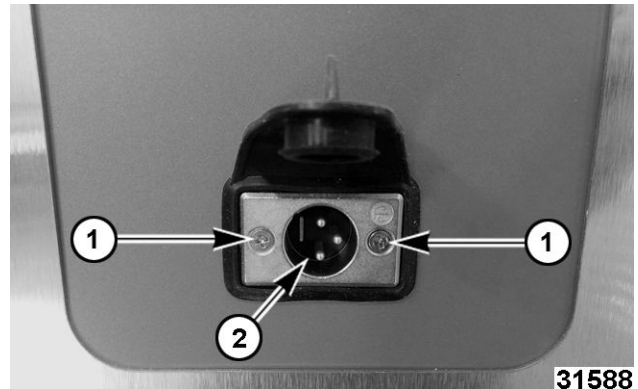

Fig. 48

5. Reverse procedure to install.
6. Align prongs (2, Fig. 48) as shown so meat probe (1, Fig. 49) plugs in with cord down.



Fig. 49

7. Check for proper operation.

NOTICE

The door operation (latch, handle and sealing) can be negatively affected any time the control panel has been moved for servicing. Verify door latch alignment with door by opening and closing door when Control Panel is loosely mounted AND when securely mounted. If door is not operational, perform DOOR TO CONTROL PANEL ALIGNMENT.

REAR COOLING FAN



WARNING

Disconnect the electrical power to the machine and follow lockout / tagout procedures.

1. Remove RIGHT PANEL and REAR PANEL.
2. Remove two wires going to fan.
3. Remove nuts securing fan to frame.

Current Production Shown

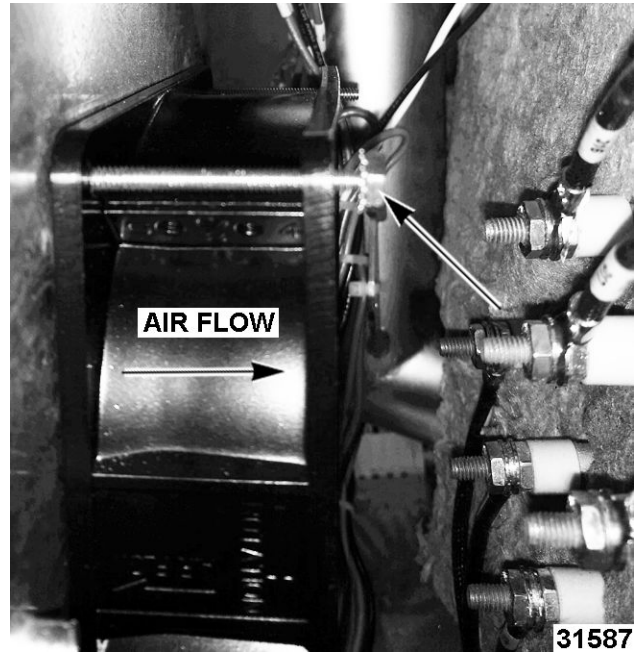

Fig. 50

4. Check for proper air flow.
5. Reverse procedure to install.

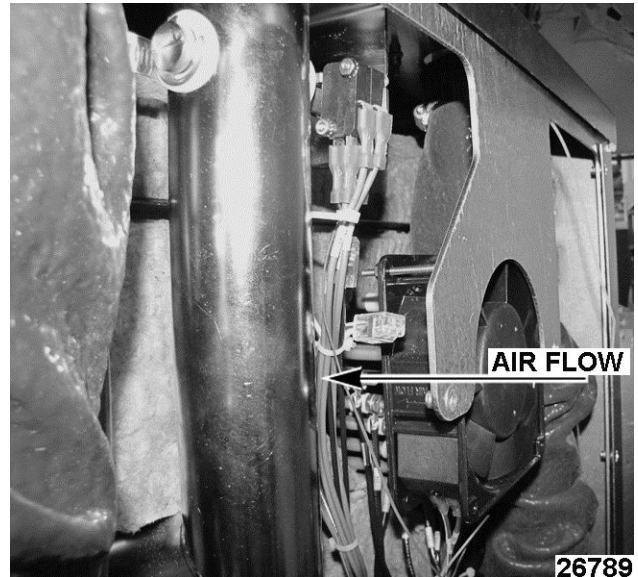

Fig. 51

HIGH-LIMIT THERMOSTAT



WARNING

Disconnect the electrical power to the machine and follow lockout / tagout procedures.

1. Remove High-limit thermostat screws.

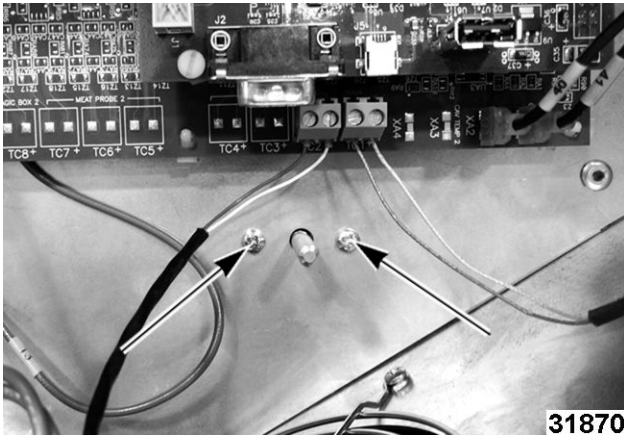

Fig. 52

2. Remove High-limit thermostat probe.

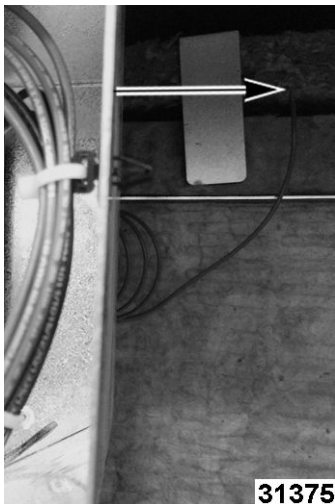

Fig. 53

NOTE: Top panel removed in photo (Fig. 54) for clarity. High-limit thermostat probe is located on top of unit, under insulation.

NOTE: Turn Probe Mounting Screw quarter turn to loosen. Do not remove probe mounting screw and bracket.

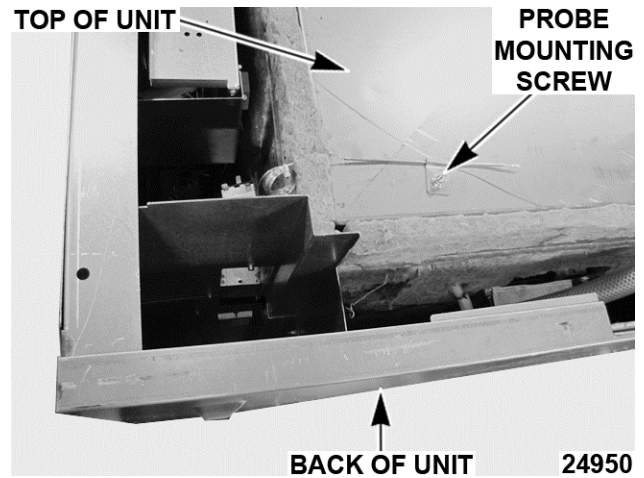

Fig. 54

3. Reverse procedures to install.

NOTE: When installing High-limit thermostat verify high-limit shaft is turned clockwise until it stops.

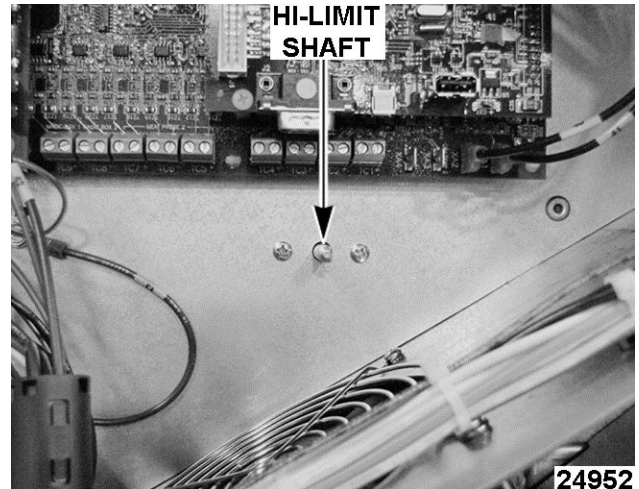

Fig. 55

4. Check for proper operation.

CAVITY INTAKE TUBE ASSEMBLY



WARNING

Disconnect the electrical power to the machine and follow lockout / tagout procedures.

1. Remove RIGHT PANEL and REAR PANEL.
2. Disconnect plug P3 (1, Fig. 56), located on right side.

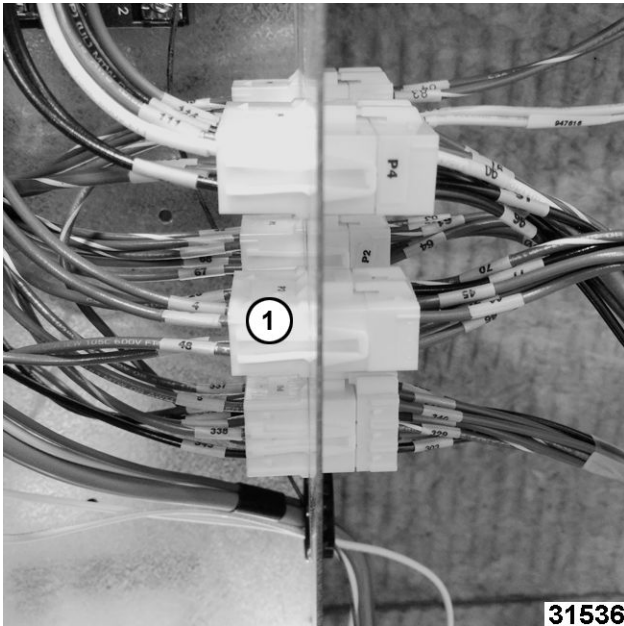

Fig. 56

- Cut cable ties as needed to release wiring harness back to vent motor and switches.

NOTE: Note location of cable ties and wire routing. Vent motor and switch cables have a strain relief.

- Remove motor shroud. (1, Fig. 57)

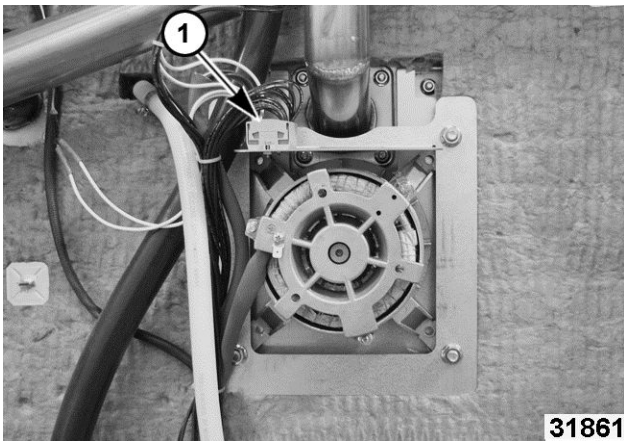

Fig. 57

- Remove four nuts securing intake vent tube assembly to back of cavity.

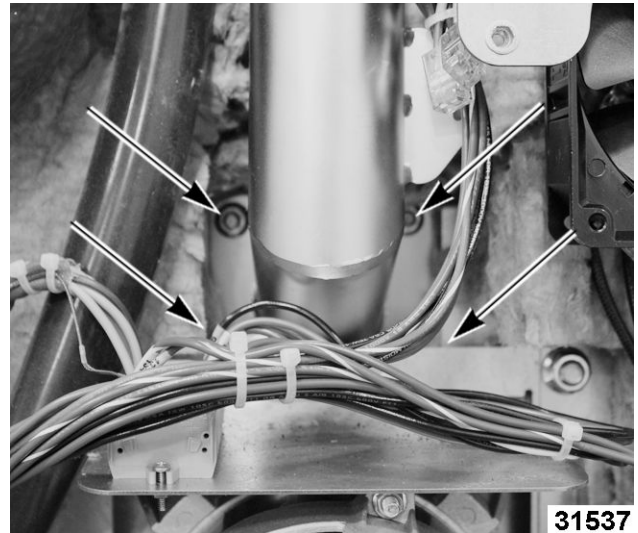

Fig. 58

- Replace parts as needed.
- Reverse procedure to install.

NOTICE

Torque cavity intake nuts to 24 in. lbs.

NOTE: There is a gasket between cavity intake tube and the cavity. This gasket should be replaced.

- Check for proper operation.

CAVITY VENT MOTOR



WARNING

Disconnect the electrical power to the machine and follow lockout / tagout procedures.

- Remove REAR PANEL.
- Remove CAVITY INTAKE TUBE ASSEMBLY.
- Rotate damper camshaft until set screw faces the rear of the cavity intake tube assembly.

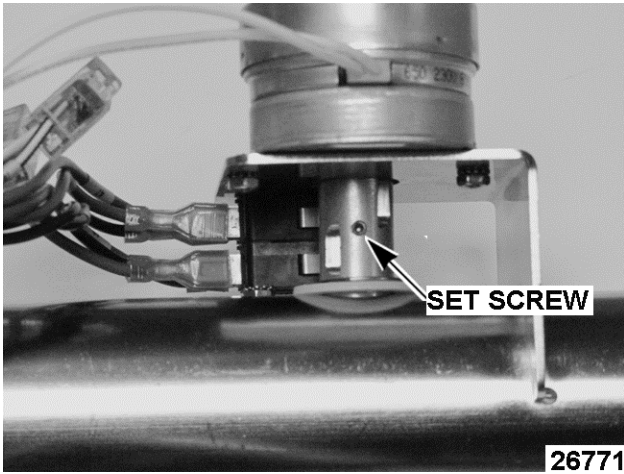

Fig. 59

4. Loosen set screw.
5. Remove two screws securing the vent motor to the frame.
6. Pull motor free from assembly.
7. Insert blade of small screwdriver into wire nuts to release motor wires.

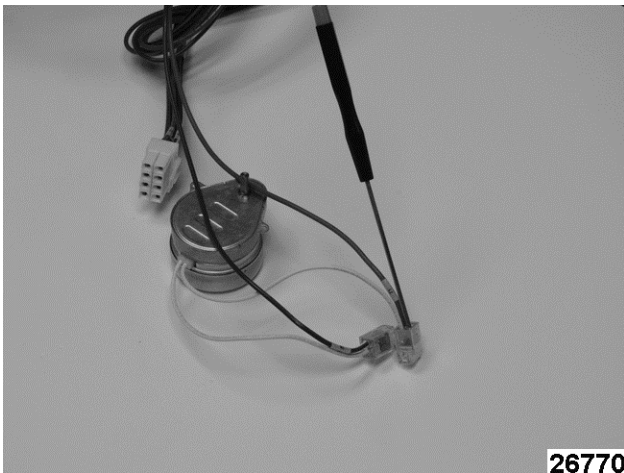

Fig. 60

NOTE: A small straight blade screwdriver (jeweler screwdriver) is needed.

NOTE: If a small screwdriver is not available, cutting the wires and using a standard wire nut is acceptable.

8. Reverse procedure to install.

NOTICE

When inserting new motor, ensure flat side of motor shaft faces the set screw.

NOTE: Note location of cable ties and wire routing. Vent motor and switch cables have a strain relief.

9. Check CAVITY VENT SWITCH TEST AND ADJUSTMENT.

10. Check for proper operation.

CAVITY VENT SWITCHES



WARNING

Disconnect the electrical power to the machine and follow lockout / tagout procedures.

1. Remove RIGHT PANEL and REAR PANEL.
2. Remove wires going to cavity vent switches.

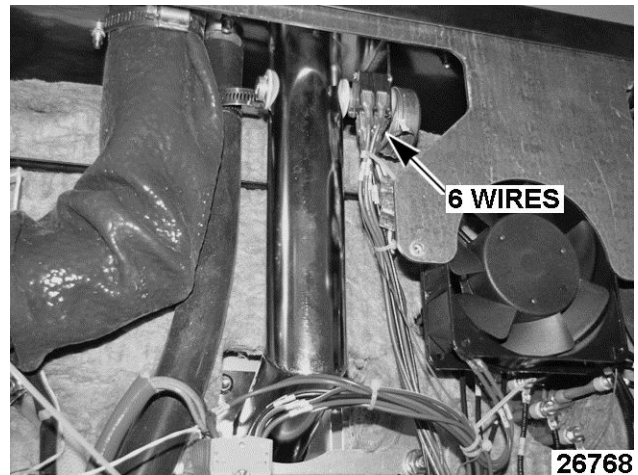

Fig. 61

3. Remove screws and remove switches to frame.

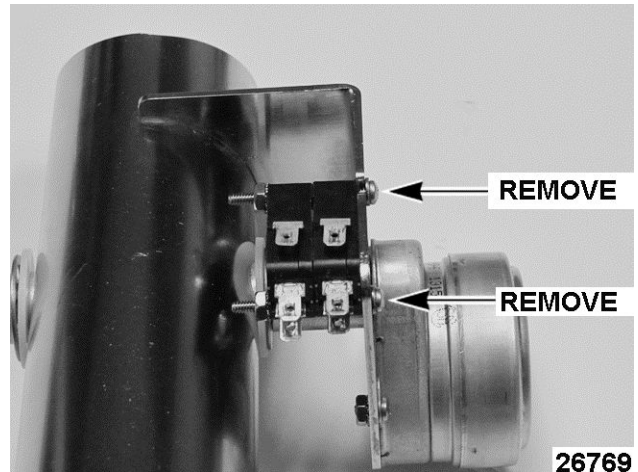

Fig. 62

4. Loosen top screw and remove switches from frame.
5. Replace switch or switches as needed.
6. Reverse procedure to install.
7. Attach wires to switches.

NOTE: Note location of cable ties and wire routing. Vent motor and switch cables have a strain relief.

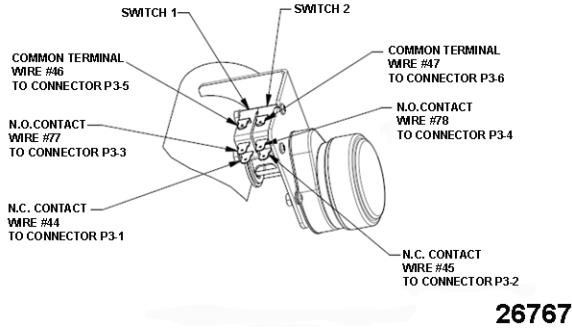

Fig. 63

8. Perform CAVITY VENT SWITCH TEST AND ADJUSTMENT.

TRANSFORMER



WARNING

Disconnect the electrical power to the machine and follow lockout / tagout procedures.

1. Remove RIGHT PANEL.
2. Disconnect plugs P7 (1, Fig. 64) and P8 (2, Fig. 64) going to transformer (3, Fig. 64).

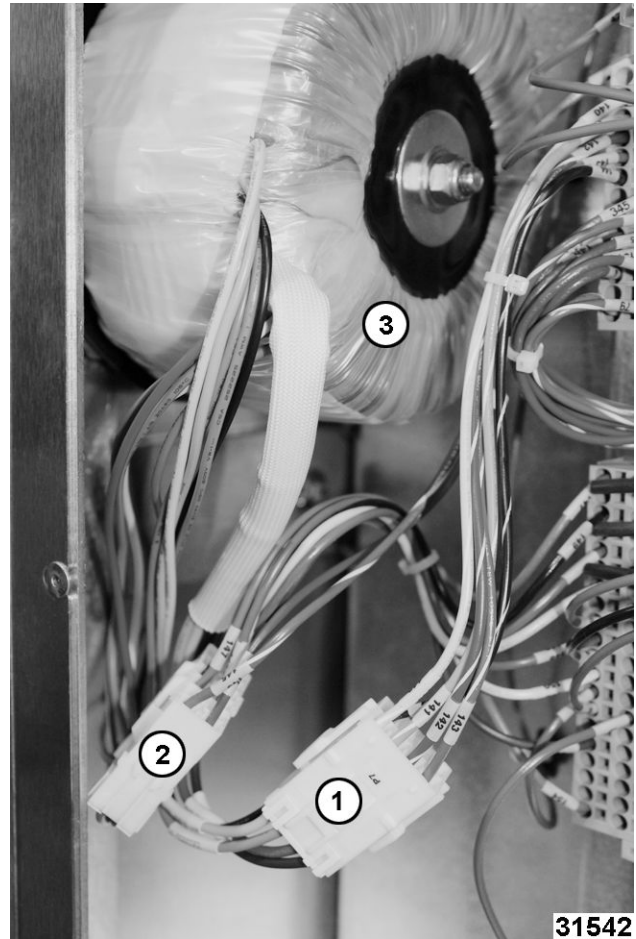

Fig. 64

3. Remove two nuts on left hand side of transformer bracket.

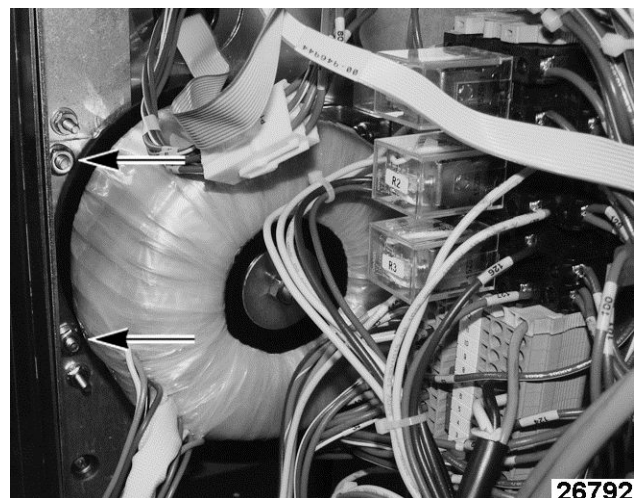

Fig. 65

4. Remove nut on the right hand side of transformer bracket.

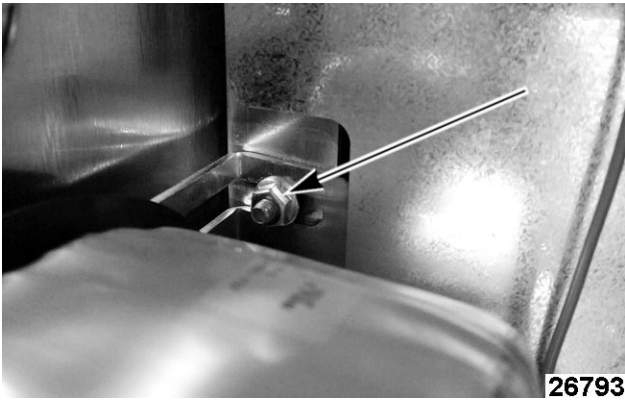

Fig. 66

CAUTION

Transformer weighs 12.5 pounds and has a strong magnetic pull to the frame of oven.

5. Slide transformer off studs and down to bottom of the oven.



Fig. 67

6. Remove transformer and bracket from oven.
7. Remove nut and washer securing transformer to bracket.

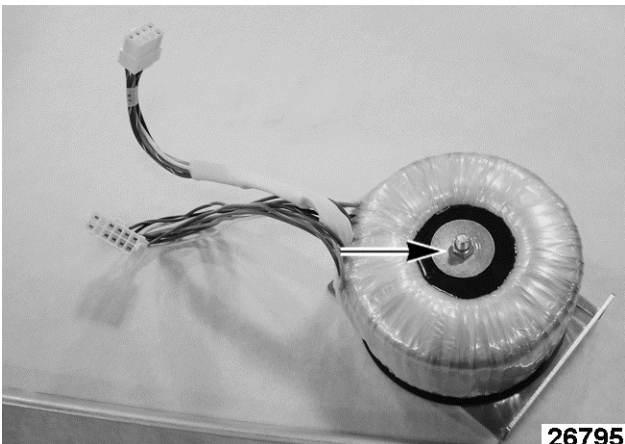

Fig. 68

8. Replace transformer.
9. Tighten nyloc nut to 75 in. lbs. to ensure transformer does not rotate loose.
10. Reverse procedure to install.

TEMPERATURE SENSOR (RTD1)



WARNING

Disconnect the electrical power to the machine and follow lockout / tagout procedures.

1. Remove RIGHT PANEL.
2. Remove REAR PANEL.
3. Remove all RTD wires.
4. Remove black wire from TB2-3 and red wire from TB2-4

NOTE: Insert small screwdriver in square next to the wire to release the wire from terminal block.

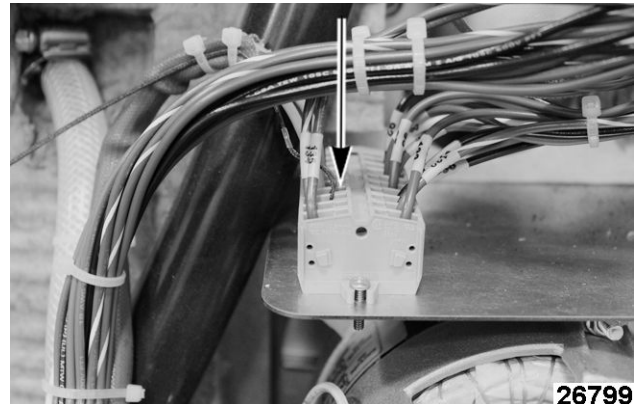

Fig. 69

5. Remove OXYGEN SENSOR.
6. Remove insulation.

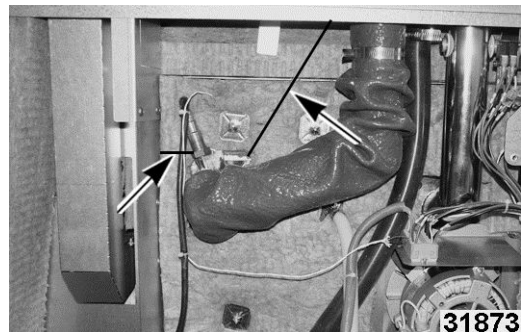

Fig. 70

- A. Cut outer layer of insulation.

- B. Pull upper insulation clip out and slide over out of the way.
- C. Spin square insulation clip holding outer layer.
- D. Carefully remove outer layer of insulation and set aside for reinstalling.
- E. Cut inner layer of insulation.
- F. Spin square insulation clip holding inner layer.
- G. Carefully remove inner layer of insulation and set aside for reinstalling.

7. Remove both RTD nuts.



Fig. 71

- 8. Remove temperature sensor RTD1 and gasket from unit.
- 9. Clean mounting surface.
- 10. Reverse procedure to install.

NOTICE

RTD wiring should exit straight out of insulation through special slot cut out in insulation and not pressed against oven cavity. Do not wire tie.

NOTICE

Verify insulation is tucked underneath upper insulation clip. Must replace insulation to prevent oven from overheating.

NOTE: Torque probe nuts at 10 in. lbs.

- 11. Check for proper operation.

DRAIN WATER CONDENSATE VALVE



WARNING

Disconnect the electrical power to the machine and follow lockout / tagout procedures.

- 1. Remove RIGHT PANEL and REAR PANEL.
- 2. Remove two screws securing valve to utility panel.



Fig. 72

- 3. Remove two wires going to valve.
- 4. Loosen hose clamp and pull valve free of hose.



Fig. 73

- 5. Replace valve.
- 6. Reverse procedure to install.
- 7. Check for proper operation.

DRAIN WATER THERMOCOUPLE



WARNING

Disconnect the electrical power to the machine and follow lockout / tagout procedures.

1. Remove RIGHT PANEL.
2. Loosen terminal TC1 screws and remove wires.

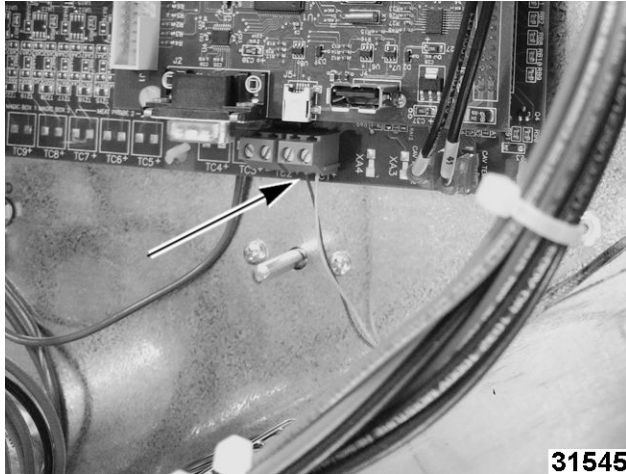

Fig. 74

3. Cut cable ties securing wires going to drain water thermocouple.
4. Loosen fitting that goes to the drain.

1st Generation Production

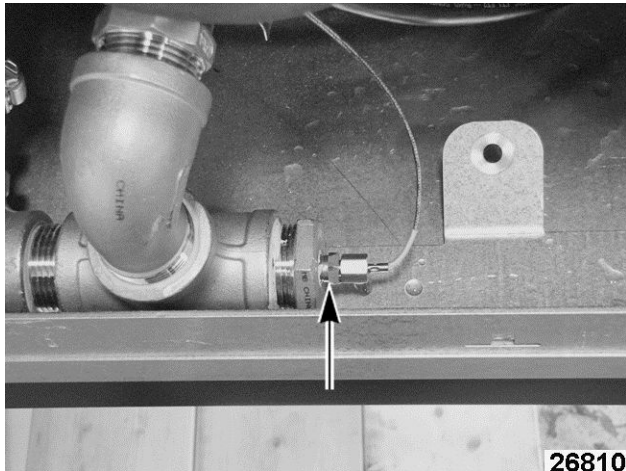

Fig. 75

2nd Generation Production

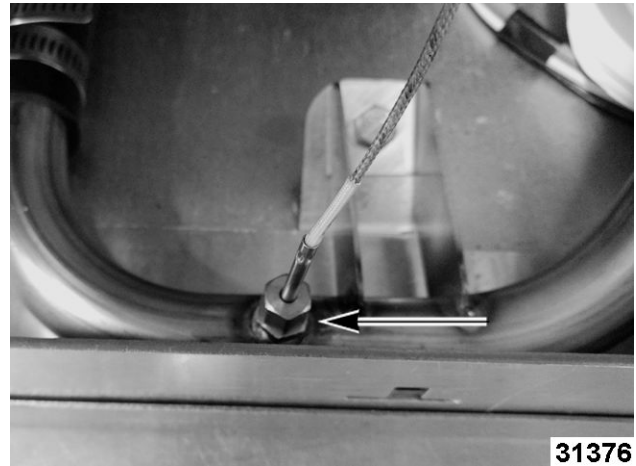

Fig. 76

5. Pull thermocouple from housing.

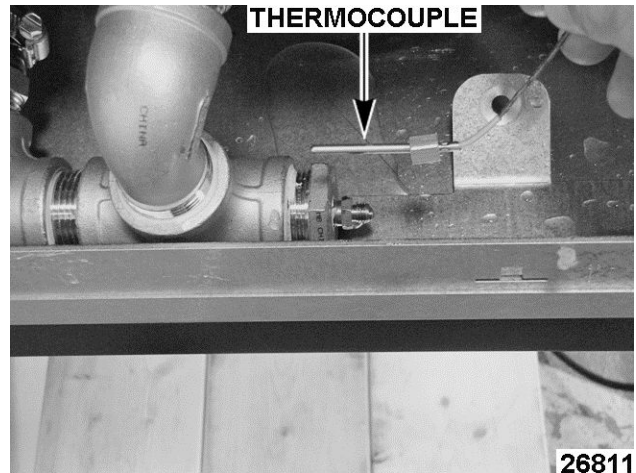

Fig. 77

6. Replace thermocouple ensuring the thermocouple is set to .800.

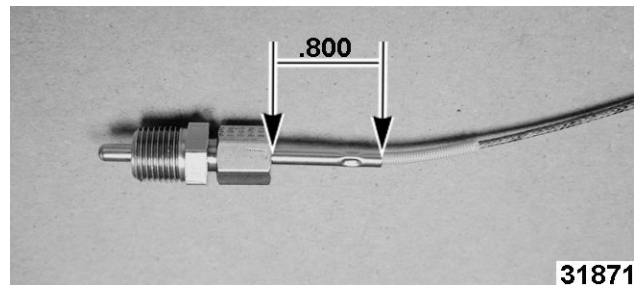

Fig. 78

7. Reverse procedure to install.
8. Refer to CONFIGURATION MODE (1972) ELECTRIC to check parameter P25, P26. based on drain type.

HUMIDITY VALVE



WARNING

Disconnect the electrical power to the machine and follow lockout / tagout procedures.

1. Remove RIGHT PANEL and REAR PANEL.
2. Remove two screws securing humidity valve to utility panel.

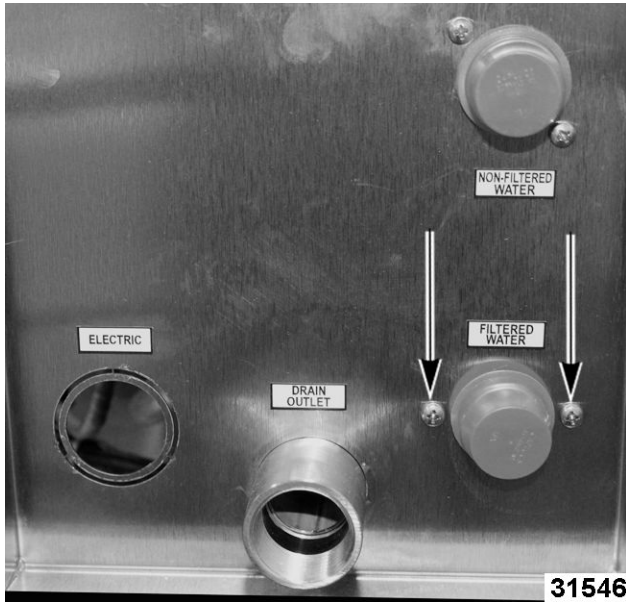

Fig. 79

NOTE: Humidity valve is a double valve.

3. Remove two wires going to drain water condensate valve.

NOTE: This makes it easier to pull the humidity valve out from behind the utility panel.

4. Remove four wires going to humidity valve.

NOTE: Make sure to note which wire goes to which terminal.

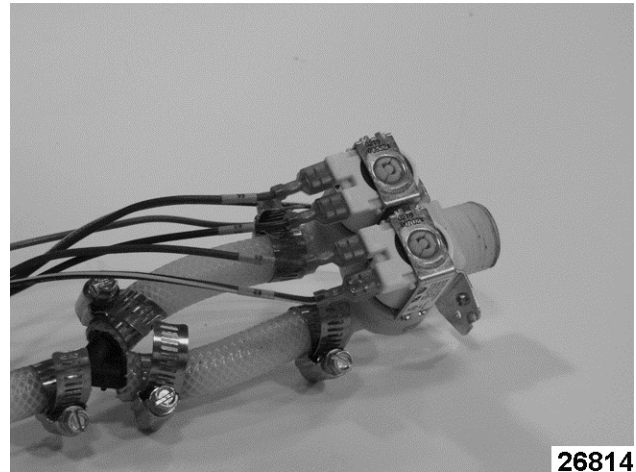

Fig. 80

5. Loosen two hose clamps securing valve and free the valve from the two hoses.

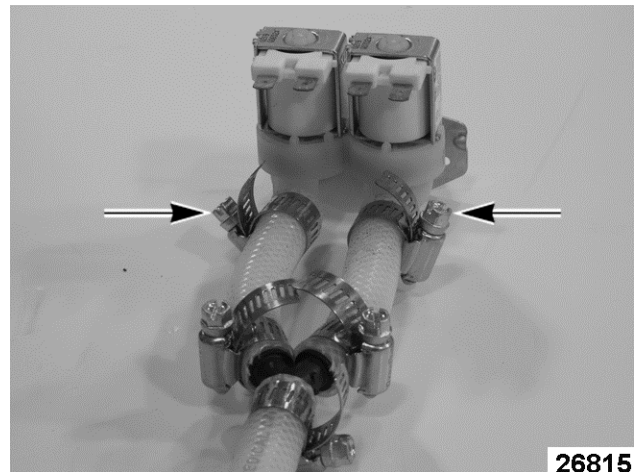

Fig. 81

6. Replace valve.

NOTICE

Correct valve orientation prevents a water "stuck on" condition. Verify water valve tubes are on top and electrical connections are on bottom when installing.

7. Reverse procedure to install.

CONVECTION FAN BAFFLE

WARNING

The oven and its parts are hot. Use care when operating, cleaning or servicing the oven.

1. Remove all oven racks (1, Fig. 82).

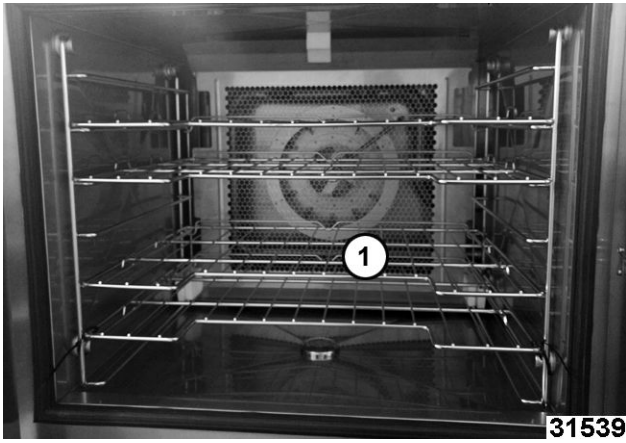

Fig. 82

- Remove left and right rack guides (1, Fig. 83).

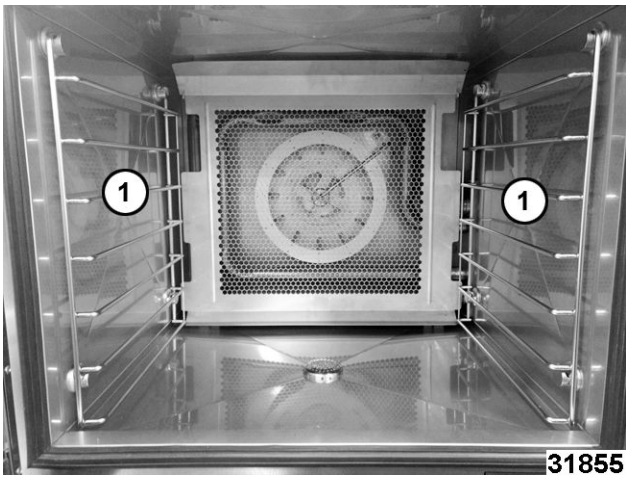

Fig. 83

- Lift baffle (1, Fig. 84) up off bottom baffle support guides (Fig. 85).
- Lift baffle over bottom rack guide hangers (2, Fig. 84).
- Lift baffle up off top baffle hangers (Fig. 85).

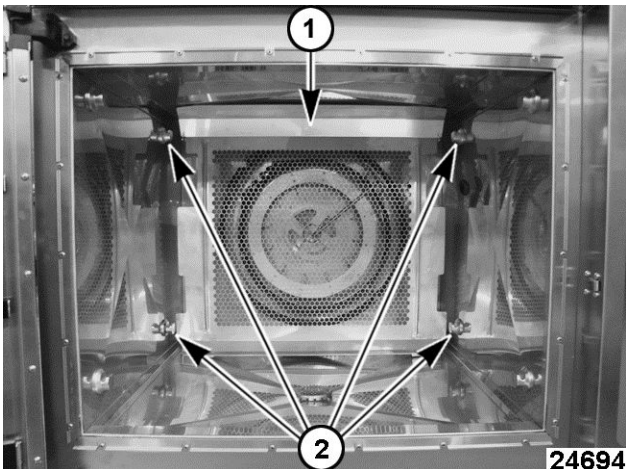

Fig. 84

- Pull towards front of oven to remove.
- Reverse procedures to install.

NOTICE

Verify convection fan baffle is hooked on top panel and supported behind bottom baffle support guides.

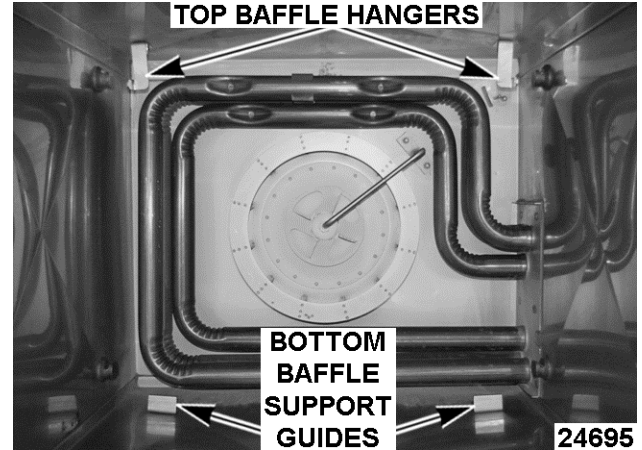

Fig. 85

CONVECTION FAN MOTOR

NOTICE

Certain components in this system are subject to damage by electrostatic discharge (ESD) during field repairs. An ESD kit is required to prevent damage. The ESD kit must be used anytime the circuit board is handled.



WARNING

Disconnect the electrical power to the machine and follow lockout / tagout procedures.

NOTE: When using gear puller to remove convection fan, do not use factory stainless steel cap screw or damage to the screw head may occur. Use a spare M6 cap screw as listed under TOOLS.

Convection Fan

- Remove RIGHT PANEL.
- Remove REAR PANEL.
- Remove humidity hose clamp (3, Fig. 86).

NOTE: Insulation removed from for clarity.

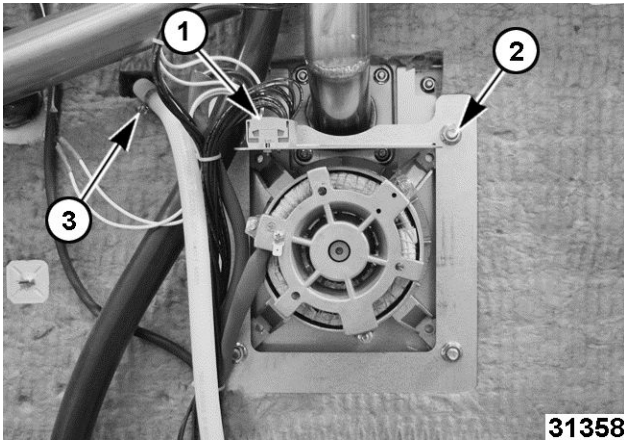

Fig. 86

4. Note and disconnect motor wires. (1, Fig. 86).

Convection Fan Terminal Block (TB2) Connection Call-outs	
A	TB Block Number
White	10
Blue	9
Black	8
Red	7
Brown	6
Brown	5

NOTICE

Any wire ties removed during removal must be replaced during installation.

5. Remove nuts, shroud and spacers if they exist. (2, Fig. 86).

NOTICE

Do not remove motor mounting nuts at this time.

6. Remove CONVECTION FAN BAFFLE.
 7. Remove humidity cavity nozzle nuts (Fig. 87) to rotate nozzle for clearance.

NOTE: Replace nozzle gasket if necessary.

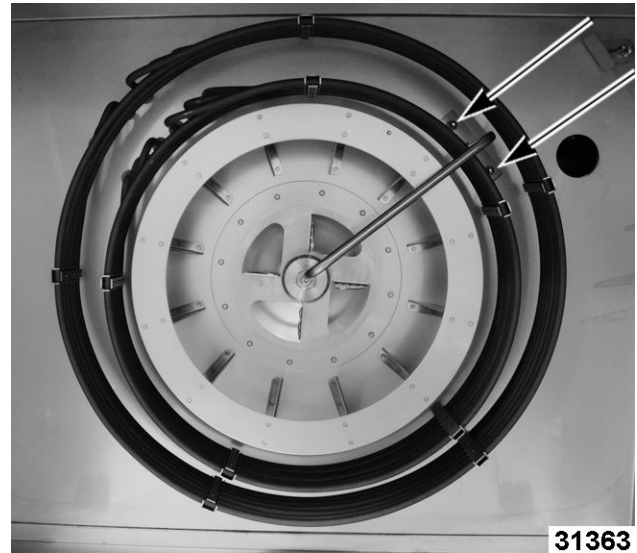

Fig. 87

8. Remove socket head cap screw.
NOTE: May need to apply heat for removal.

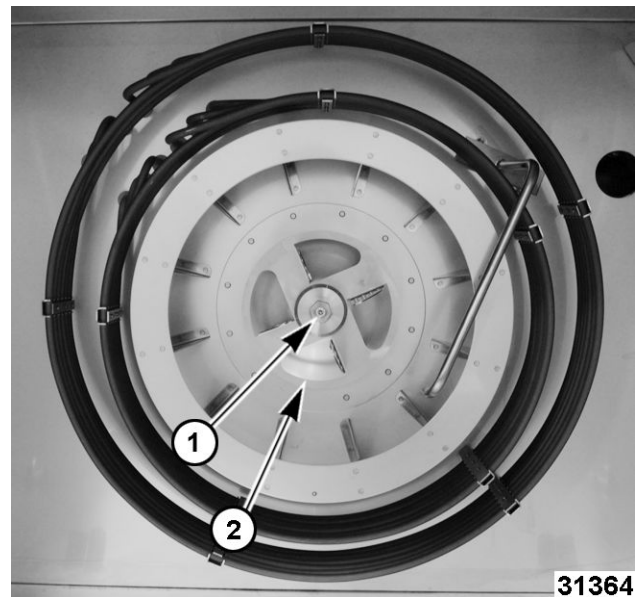

Fig. 88

9. Remove atomizer bolt (Fig. 88).
NOTE: Atomizer bolt is a left-handed bolt.
NOTE: May need to apply heat for removal.
 10. Remove water atomizer.
 11. Thread atomizer bolt into fan motor shaft. Leave approximately 1/8" space between hex head on atomizer bolt and fan hub.
 12. Insert spare M6 cap screw into fan motor shaft.
Hand tighten only.

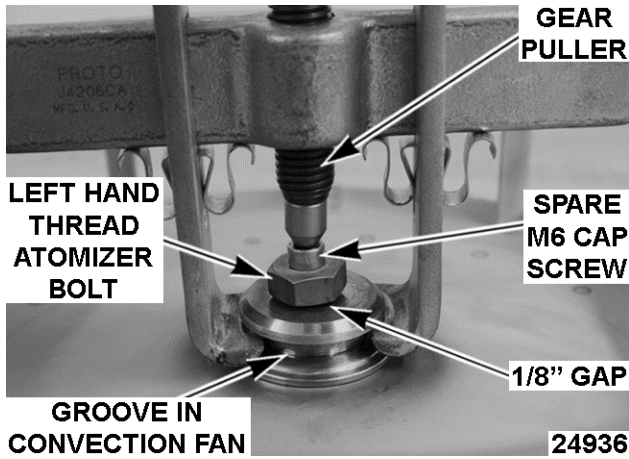

Fig. 89

13. Install gear puller.
14. Tighten gear puller to separate convection fan from motor shaft.

NOTE: Applying heat uniformly to groove in convection fan will assist with separation of fan and motor shaft.

15. Note and disconnect motor wires from convection fan terminal block.
16. Remove motor mounting nuts.
17. Reverse procedure to install.

NOTE: Verify motor wire orientation before installing.

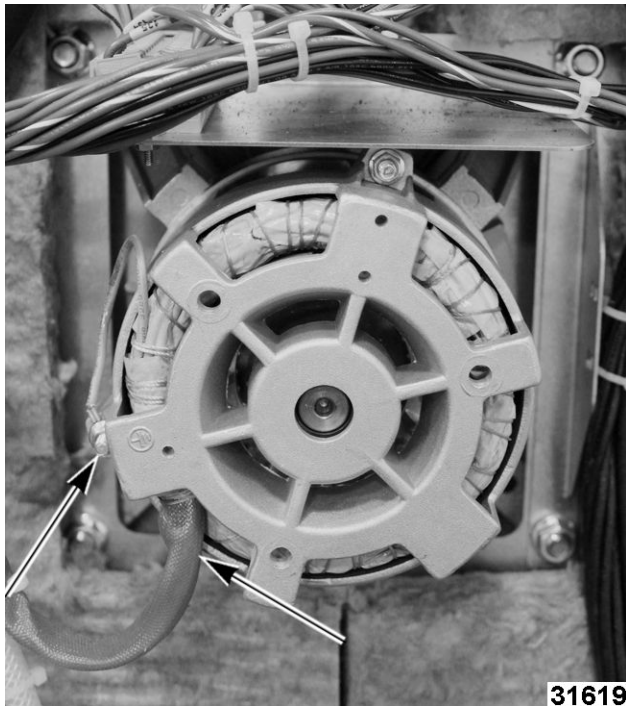

Fig. 90

NOTICE

Apply Loctite™ 272 to all torqued threads.

18. Set specific torques when installing.
 - Torque motor mount nuts to 240 in. lbs.
 - Torque atomizer bolt to 350 in. lbs.
 - Torque atomizer socket head cap screw to 75 in. lbs.
 - Verify atomizer nozzle is aligned with center of atomizer blade locking screw and torque nuts to 75 in. lbs.

NOTE: Tighten atomizer nozzle clamp after baffle, rack guides and racks are installed.

19. Check for proper operation.

HEATING ELEMENTS



WARNING

Disconnect the electrical power to the machine and follow lockout / tagout procedures.



Fig. 91

NOTE: Elements go from standard threads to metric. [ABC Combi Element Change Video](#)

NOTE: Continue reading for more details.

NOTICE

Element assembly has changed threads from standard to metric. This will require different tools for removal and installation. Standard shown in Fig. 92, Metric shown in Fig. 93.

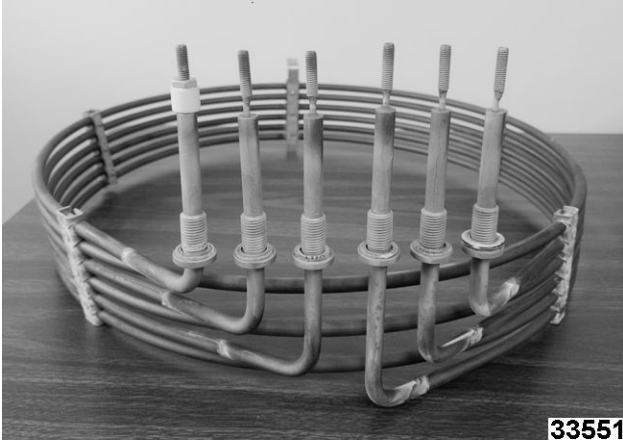

Fig. 92

NOTE: Element with metric threads will have a bend in the elements as shown.

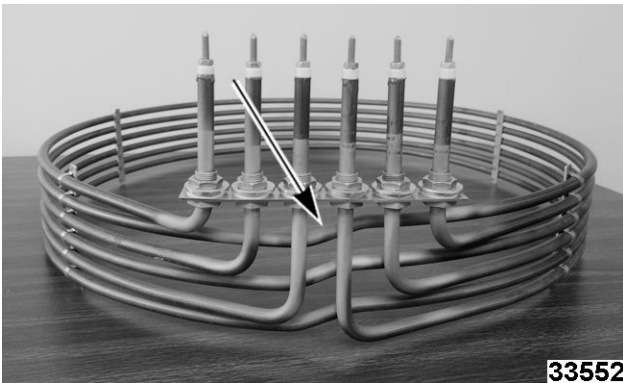

Fig. 93

1. Remove CONVECTION FAN BAFFLE.
2. Remove RIGHT PANEL and REAR PANEL.
3. Remove REAR COOLING FAN.

NOTE: The rear fan is attached to a bundle of wires. It is OK to allow fan hang from wire tie for this procedure.

4. Remove nut securing support bracket of the heating element(s) to be removed.

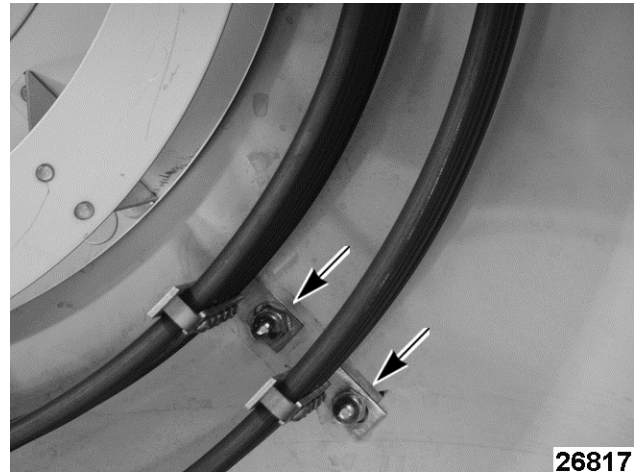

Fig. 94

5. Replace heating element.

- A. Remove two nuts securing nozzle to oven cavity.

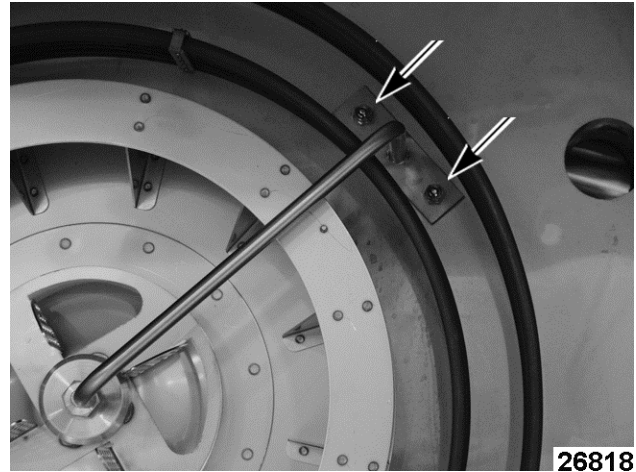

Fig. 95

- B. Loosen hose clamp securing hose to nozzle.



Fig. 96

- C. Pull hose free of nozzle.

NOTE: Nozzle is now loose, but it is easier to remove nozzle and heating element at the same time.

6. Remove leads going to heating element to be removed.
 - Outer Elements (1, Fig. 97).
 - Inner Elements (2, Fig. 97).

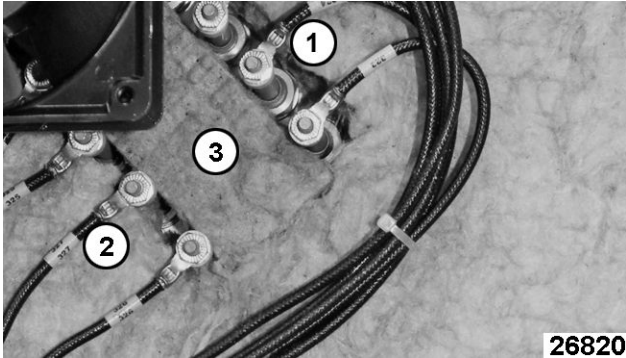

Fig. 97

NOTE: On each lead there is the following, nut / washer / terminal lead / washer / nut / ceramic insulator. All of which needs to be removed.

7. Carefully pull center piece of insulation out for clearance to element.
8. Remove the nuts and lock washers securing heating element.

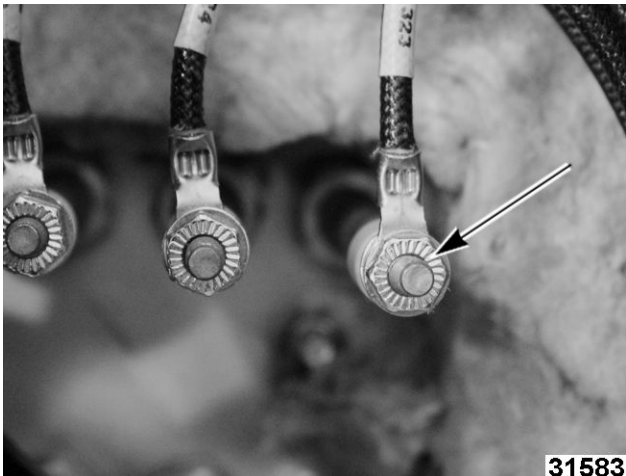

Fig. 98

NOTE: This will require either a pass thru socket and ratchet or several 11/16" deep well sockets welded together.

9. Remove heating element.

NOTE: This will require either a pass thru socket and ratchet or several M12 deep well sockets welded together.

10. Reassemble in reverse order.

- A. Install and torque outer nuts.
- B. Install and torque bulk head/cavity nut.
- C. Verify torque values for metric size threads.

NOTICE

Torque M4 nuts (10 in lbs./1.2 N.m) (first) outer nut (20 in.Lbs/2.3 N.m) and (180 in lbs/20 N.m) for bulk head/ Cavity nut.

WARNING

Verify wires have gap between them as shown to prevent shortage. Install wire ties that have been cut while replacing element(s).

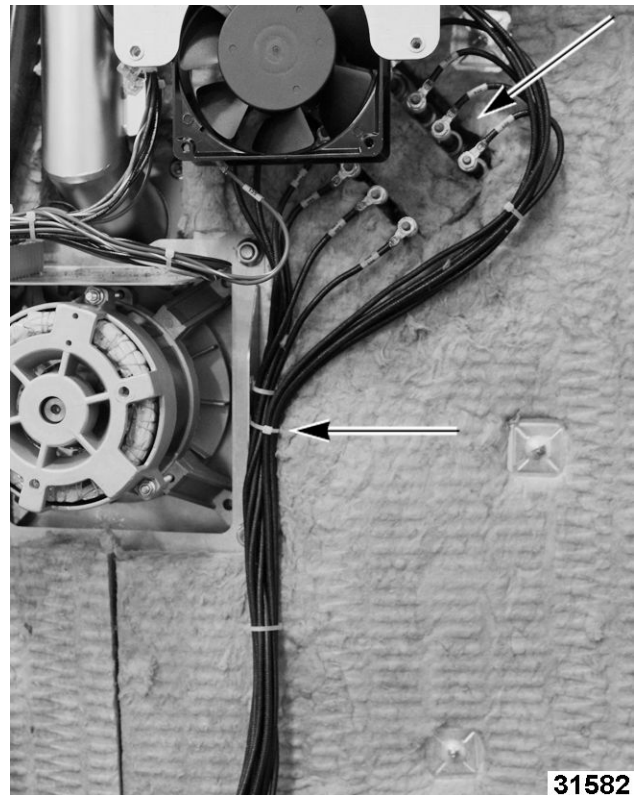

Fig. 99

CONTACTORS



WARNING

Disconnect the electrical power to the machine and follow lockout / tagout procedures.

1. Remove RIGHT PANEL.
2. Remove wires going to T1, T2 and T3 of the contactor to be replaced.
3. Remove wires from back side of contactor.

NOTE: Use a flat screwdriver to pull out orange tab (1, Fig. 100) to release contactor from DIN rail.

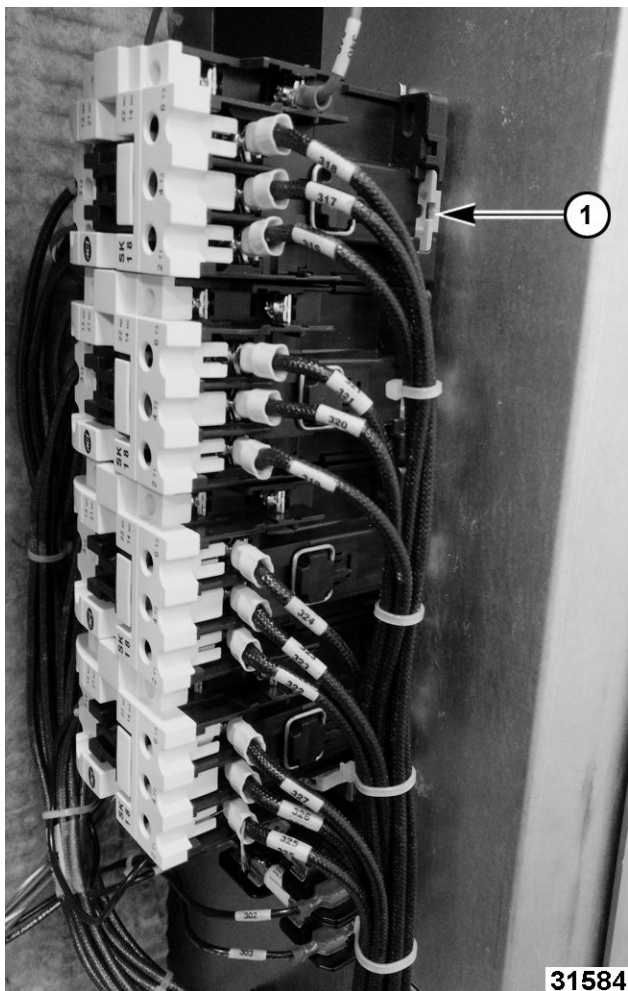

Fig. 100

4. Replace contactor and reassembly in reverse order.

NOTICE

Contactor torque specifications are listed on contactors.

SERVICE PROCEDURES AND ADJUSTMENTS



⚠ WARNING

Certain procedures in this section require electrical test or measurements while power is applied to the machine. Exercise extreme caution at all times and follow Arc Flash procedures. If test points are not easily accessible, disconnect power and follow Lockout/Tagout procedures, attach test equipment and reapply power to test.

CONFIGURATION MODE (1972) ELECTRIC

Logging into Configuration Mode 1972

1. Check with customer to verify settings have not been altered from factory settings.
2. Turn unit on.

NOTE: Oven must have no temp set to enter configuration.
3. Turn Timer knob counterclockwise until Timer display shows "set".
4. Turn Humidity knob counterclockwise until Humidity display shows "PAS".
 - A. Timer display will show "2000".
5. Turn Timer display counterclockwise to 1972.
 - A. Timer display will flash "1972".
 - B. Timer and Humidity display will flash twice.
 - C. Humidity display changes from "PAS" to "CFg" when logging into Configuration Mode.
 - D. Temperature Display will go to P0, which is the first configuration setting.

Reviewing / Changing Configuration Mode 1972 Settings

1. Turn the Temperature knob clockwise one step at a time, to go to the next configuration setting.

NOTE: Currently addresses P22, P30, and P31 are blank.
2. Presently P35 is the last address, the counter will continue to go higher, but the Time display and the Humidity display will be blank.
3. Turn the Humidity Knob to change the values as needed.
4. Refer to: "**Configuration Mode (1972) Settings**" chart below for options.

Logging out of Configuration Mode 1972

1. Turn Temperature knob counterclockwise until "---" displayed.

NOTE: In table below, default setting text is **BOLD**.

Configuration Mode (1972) Settings			
Temp. Display ("---")	Description	Time Display ("----")	Humidity Display ("---")
P0	Current firmware code revision (Month, day, year).	0424 (Month: 04, Day: 24)	17 (Year: 2017) Letter after number. = Revision within a date.
P1	Set temperature to Fahrenheit or Celsius.	UnIt	F or C
P2	Temperature knob increments. Temperature increment can be adjusted by 1, 5, or 10 degrees.	tInC	1, 5 , 10, 25
P3	Humidity knob increments. Humidity can be adjusted by 1 or 10 percent increments.	HInC	1 and 10
P4	Custom Operator Interface		Turn Hum knob between Factory (FACT) and Custom (CUST).
	Factory Default UI Setting	FACT	
	Custom UI Setting	CUST	
	NOTE: Operator can flip between P4 FACT and P4 CUST. Custom settings will be remembered. NOTE: Only when P4 is set to custom can settings in P5 and P6 be configured.		
P5	Define Temperature Selection in UI NOTE: Only when P4 is set to custom can settings in P5 and P6 be configured.	FACT	
		CUST (Indicates customer settings are currently loaded.)	SEt Turn knob to edit custom settings.
		ALL	oN TIP: Select "ALL on" to begin customizing if minimal changes needed to FACT settings.

Configuration Mode (1972) Settings			
Temp. Display ("---")	Description	Time Display ("----")	Humidity Display ("---")
		ALL	oFF TIP: Select "ALL oFF" if you want to start customizing from scratch.
		80 (min) 482 (max) Turn Timer knob through temperature choices.	oFF / on Hum knob can be toggled to change individual temperature on or off.
P6	Define Humidity Selection in UI NOTE: Only when P4 is set to custom can settings in P5 and P6 be configured.	FACT	
		80 (F) . . . 482 (F) Turn Timer knob through temperature choices.	90 (% humidity) . . . 0 (%) Hum knob can be used to change humidity mapping to selected temperature.
NOTE: The following is an example of customizing the P4 through P6 settings.			
P4	P4 set to CUS _t Example. 1. Toggle Hum knob to select CUS _t settings.	CUS _t	
P5	2. Turn Temperature knob to P5. 3. Toggle Hum knob oFF.	ALL	oFF
	4. Scroll timer knob to temperature of 212. 5. Toggle humidity knob to on.	212(F)	on
	6. Scroll timer knob to 325. 7. Toggle humidity knob to on.	325(F)	on
P6	8. Turn Temperature knob to P6.		
	9. Scroll timer knob to 325. 10. Toggle knob to 0%.	212(F) 325(F)	100(%) 0(%)

Configuration Mode (1972) Settings			
Temp. Display ("---")	Description	Time Display ("----")	Humidity Display ("---")
	11. At completion, user interface is customized so user can only select 212F @ 100% or 325F @ 0%.		
End of example.			
P7	Allows users to manual adjust humidity settings during operation.	HAdJ	on / oFF
P8	Oven Buzzer ON - Buzzer stops after 5 seconds. OFF - Buzzer turns on until door is opened or timer is turned off.	b 5	on / oFF
P9	Door Lights ON - Door lights flash at end of timer countdown. OFF - Door lights do not flash at end of countdown.	FLSH	on / oFF
P10	Batch Timer. Timer recalls last operated value when door is opened and closed after buzzer. User does not need to reset timer. For example, User removes a batch of fries from oven and puts in a second batch of fries.	trCL	on / oFF
P11	Clean reminder. "CLn good bYE" shown when on/off switch is toggled off.	CLn	on / oFF
P12	Convection Fan Speed. • Non-adjustable: units without probe. or units 8-11-14 FIRMWARE and prior. • Units with Probe only (adjustable). • 1400+ RPMs • 700-900-1250 RPMs • 525-700-900 RPMs NOTE: Speed selected for F1 must always be below F2.	F3	7
		Turn Timer Knob	
		F2	4-6
		Turn Timer Knob	
		F1	3-5
P13	Convection Fan Breaking Speed (not adjustable).	F br	5
P14	Reversing fan timing. Number of minutes cavity fan turns before breaking and turning in opposite direction.	FrEU	Off, 2, 3, 4, 5
P15	Define maximum temperature knob setting in UI. Maximum temperature that can be set by user. Minimum setting limited by P16.	t_HI	80 through 482 increments of 1, (450 default).

Configuration Mode (1972) Settings			
Temp. Display ("---")	Description	Time Display ("----")	Humidity Display ("---")
P16	<p>Define minimum temperature knob setting in UI.</p> <p>Minimum temperature that can be set by user. Maximum setting limited by P15.</p> <p>NOTE: Must be less than P15.</p> <p>NOTE: Settings at P15 and P16 are only in effect if P4 is set to FACt.</p>	t_Lo	80 through 482 increments of 1.
P17	<p>Cavity Automatic Steam Reduction: Reduces the cavity's steam buildup before end of timed cook. Vent intake is opened "selected" seconds before end of timer countdown.</p> <p>NOTE: Steam reduction is not engaged mid-cook or during a "non-timed" cook when door opened.</p> <p>Example: P17 = 30 seconds (default). As the cook time counts down, the vent opens allowing the steam to dissipate.</p>	AUto	oFF, 30, 60, 90
P18	<p>Oven hour counter. Total hours oven has been cooking.</p> <p>Example: Timer: 0009, Humidity: 999 = 9,999 hours.</p> <p>NOTE: Counters will zero when Main I/O board is replaced.</p>	oVEn / 0009	HrS / 999
P19	<p>Humidity water counter. Total amount of water used to humidity oven in gallons.</p> <p>Example: Timer: 0009, Humidity: 999 = 9,999 gallons.</p> <p>NOTE: Counters will zero when Main I/O board is replaced.</p> <p>NOTE: Add P19 & P20 for total water usage.</p>	HUn / 0009	gAL / 999
P20	<p>Condensate tempering water counter. Total amount of water used to cool drain water in gallons.</p> <p>NOTE: Counters will zero when Main I/O board is replaced.</p> <p>NOTE: Add P19 & P20 for total water usage.</p>	Cond / 000	gAL / 00
P21	<p>External Meat Probe Thermocouple Calibration (temperature offset).</p> <p>Refer to <u>EXTERNAL MEAT PROBE THERMOCOUPLE CALIBRATION</u> .</p>	<p>PCAL</p> <p>Turn Timer knob to view current calculated probe temp TC2 with P21 applied for ease of calibration.</p> <p>Example: 170(F)</p>	<p>Turn Humidity knob clockwise for positive offset or counterclockwise for negative offset.</p> <p>-10°F through +10°F increments of 1</p> <p>Default 0</p>

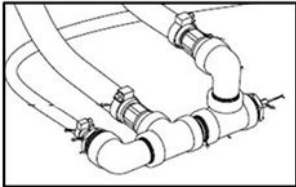
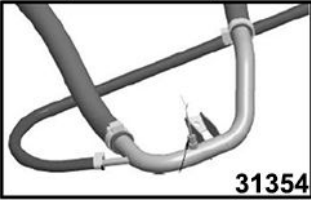
Configuration Mode (1972) Settings			
Temp. Display ("---")	Description	Time Display ("----")	Humidity Display ("---")
P23	<p>Demo Mode</p> <p>Used for sales. All functions operable except for heat.</p> <p>Disables critical errors.</p> <p>NOTE: Display will show "ABC trY it" after on/off switch is turned off.</p>	dEno	on
P24	<p>Temperature calibration (Temperature Offset)</p> <p>Refer to temperature calibration in service and adjustment procedures.</p>	oCAL	<p>Turn humidity knob clockwise for positive offset, to lower overall cavity temperature.</p> <p>Turn humidity knob counterclockwise for negative offset, to raise overall cavity temperature.</p> <p>-15 through 15 increments of 1.</p> <p>Default 0</p>
P25	<p>Condensate drain sensor activate temp.</p> <p>Temperature at which to run cooling water into drain trap to achieve the proper exit temperature of the drain water.</p> <p>NOTE: P25 and P26 are interdependent. The system requires P26 setting less than P25.</p> <p>Important: This parameter needs to be set based on drain type, not based on firmware revision.</p> <div style="display: flex; justify-content: space-around; align-items: center;"> <div style="text-align: center;"> <p>OLD (NPT Pipe Fittings)</p>  </div> <div style="text-align: center;"> <p>NEW (Bent Tube)</p>  </div> </div> <p style="text-align: center;">Fig. 101</p>	dron	<p>Tc1 =120 thru 160 Increments of 1.</p> <p>140 (old drain, regardless of firmware revision)</p> <p>160 (new drain, regardless of firmware revision)</p>

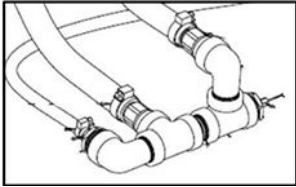
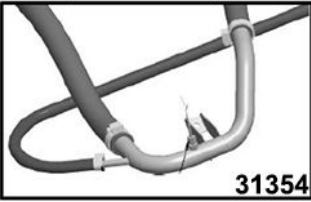
Configuration Mode (1972) Settings			
Temp. Display ("---")	Description	Time Display ("----")	Humidity Display ("---")
P26	<p>Condensate drain sensor deactivate temp. Temperature at which to stop cooling water into the drain trap to achieve proper exit temperature of drain water.</p> <p>NOTE: P25 and P26 are interdependent. The system requires P26 setting less than P25.</p> <p>Important: This parameter needs to be set based on drain type, not based on firmware revision.</p> <div style="display: flex; justify-content: space-around; align-items: center;"> <div style="text-align: center;"> <p>OLD (NPT Pipe Fittings)</p>  </div> <div style="text-align: center;"> <p>NEW (Bent Tube)</p>  </div> </div> <p style="text-align: center;">Fig. 102</p>	droF	<p>tC1 = 115 thru 155 increments of 1.</p> <p>130 (old drain, regardless of firmware revision)</p> <p>155 (new drain, regardless of firmware revision)</p>
P27	<p>Condensate tempering probe.</p> <p>Enabled: Tempering of drain water based on condensate probe temperature (Energy efficient). See P25 & P26.</p> <p>Disabled: Continuous time-based tempering when in steam mode. (Less energy efficient.)</p>	StPr	EnA / d15
P28	<p>Additional Humidity knob operator interface.</p> <p>Enabled: Customer has option to turn humidity knob below 0, to a "---" setpoint. In this mode, vent is forced closed and no humidity water valve operation.</p> <p>Disabled: Humidity knob choices are set between 0 to 100%.</p>	AStn	EnA / d15
P29	User Interface (Push button functions) Cook-to-Probe & Fan Speed Control separately enabled/disabled.	P_UI	EnA/dIS
		Scroll Timer Knob	
		F_UI	EnA/dIS
P32	<p>Oxygen board calibrate / zero. (Only recommended for high altitudes.)</p>	ZEro	<p>no</p> <p>Turning knob to "yes" indicates a multi-step procedure.</p>
P33	<p>Oxygen Sensor Data</p> <p>Shown in % of Absolute Humidity. This value will not match the % Relative Humidity value shown on User Interface at oven cavity temperatures < 212°F.</p> <p>ONLY USED WHEN CALIBRATING OXYGEN SENSOR. (Refer to calibrating oxygen sensor board in service manual.)</p>	51	.2
		NOTE: Combine the two numbers to get 51.2%.	

Configuration Mode (1972) Settings			
Temp. Display ("---")	Description	Time Display ("----")	Humidity Display ("---")
P34	Humidification method (not adjustable). Disabled (default) allows for oxygen sensor based humidification at all humidity setpoints <100%. Enabled (future) employs a non-oxygen sensor based humidification method.	drIP	EnA/dIS
P35	Reset parameters to factory default values. To reset values to factory default: 1. Turn humidity knob clockwise to YES. Timer display flashes "----". 2. Turn timer knob clockwise to spell "rSET", one letter at a time. NOTE: Humidity display will read don, when the parameters have been reset. NOTE: This will reset P4,5,6 Custom settings.	rSET	no / YES don

CALIBRATING OXYGEN SENSOR BOARD

NOTICE

Oxygen sensor board needs to be calibrated when oven is installed at high altitude, otherwise do not calibrate.

1. Check oven temperature to verify oven temperature is below 100°F.
2. Open cavity door and keep open.
3. Towel dry cavity floor to ensure no standing water or steam in cavity.

NOTE: May need to remove racks to dry cavity floor.

4. Turn oven on and wait at least 3 minutes for sensor to warm up.
5. Log into Configuration Mode (1972).
6. Turn temperature knob clockwise to "P33".
 - Timer display should read between 0 and 24.
 - Humidity display should read between .00 and .99.

NOTE: If timer displays "----" when viewing P33, oxygen sensor is warming. Wait 3 minutes. When ready, Timer / Humidity display will change to a numeric value.

7. Turn temperature knob counterclockwise to P32.
 - Timer displays "ZEro".
 - Humidity displays "no".

8. Turn humidity knob clockwise to "yes" with cavity door open, to initiate the calibration process.

NOTE: Timer display will toggle between "OPEN" and "DOOR", and beeps if door is closed. Timer displays "dry", humidity displays "no", after confirming cavity is dry.

9. Turn humidity knob to "yes" to confirm cavity is dry.
 - Convection fan will turn on.
 - Timer display flashes "---" when conditions are ready for calibration.

NOTE: Oven cavity temperature must be below 100°F. If temperature not less than 100°F / 38°C, timer display toggles cool/xxx°F (xxx°F / xxx°C = current temperature), until temperature is below 100°F / 38°C.

NOTE: If conditions are not met: ("P33" less than or equal to 24, cavity temperature less than 100°F / 38°C, with door open, and convection fan up to speed), the system will not allow user to enter 0000 in the timer and will beep.

NOTE: To exit out of calibrating oxygen sensor board before calibrating, turn Humidity knob to "no" or turn Temperature knob to exit.

10. Turn timer knob clockwise to "0000", one digit at a time to calibrate the sensor.
 - Humidity display should read between .00 and .99.
 - Timer displays "donE" and Humidity displays "yes" when complete.
 - Convection fan turns off.
11. Check oxygen sensor board.
 - A. Turn temperature knob clockwise to "P33".
 - Timer display should read between 0 and 2.
 - B. Turn temperature knob counterclockwise until "---" displayed to exit out of configuration mode 1972.

NOTE: This value should be near 0%. For example, timer = 2, humidity = .99, represents 2.99%.

CHECK OXYGEN SENSOR DATE CODE (REPLACEMENT SENSORS)

- Use only replacement sensors with date code August 2016 and higher.
- Date code is indicated on sensor by first 3 numbers in the location shown by the red box as shown in [Fig. 103](#).
- Replacement sensors require revision 12 oxygen sensor board firmware.
- Refer to Service Mode 1963 to check oxygen sensor board firmware revision (See Test O2).

BOSCH Date Codes

Year	JAN	FEB	MAR	APR	MAY	JUN	JUL	AUG	SEP	OCT	NOV	DEC
2013	301	302	303	304	305	306	307	308	309	310	311	312
2014	417	418	419	420	453	454	455	456	457	458	459	460
2015	517	518	519	520	553	554	555	556	557	558	559	560
2016	617	618	619	620	653	654	655	656	657	658	659	660
2017	717	718	719	720	753	754	755	756	757	758	759	760
2018	817	818	819	820	853	854	855	856	857	858	859	860
2019	917	918	919	920	953	954	955	956	957	958	959	960
2020	037	038	039	040	073	074	075	076	077	078	079	080

Fig. 103

31355

TEMPERATURE SENSOR (RTD1) TEST



⚠ WARNING

Certain procedures in this section require electrical test or measurements while power is applied to the machine. Exercise extreme caution at all times and follow Arc Flash procedures. If test points are not easily accessible, disconnect power and follow Lockout/Tagout procedures, attach test equipment and reapply power to test.

1. Remove RIGHT PANEL.
2. Remove probe lead wires from Main I/O board.
3. Test probe with an ohmmeter.
4. If out of range remove REAR PANEL, then remove wires from terminal block TB2 and test again.

TEMPERATURE in °F	RESISTANCE ±5 OHMS
60	530
70	541
80	552
90	563
100	573
125	600
150	627
200	680
250	732
300	785
350	836
400	887
450	938

TEMPERATURE CALIBRATION - ELECTRIC

1. Place temperature tester probe in geometric center of oven cavity.
2. Program a setpoint of 350°F. Allow oven temperature to cycle 3 times.

NOTE: Oven's temperature display shows setpoint. To view actual cavity temperature as it cycles around setpoint, slightly turn temperature knob clockwise one notch or counterclockwise one notch and actual cavity temperature will blink three times.

NOTE: Turning temperature knob more than one notch will change temperature setpoint.

3. Record **temperature tester** readout for an additional 3 cycles. It should cycle around setpoint.

Temperature Data Recording Table		
Temperature Tester Heater Turn On	Actual Average (Turn On + Turn Off) divide by 2	Temperature Tester Heater Turn off
_____	_____	_____
_____	_____	_____
_____	_____	_____

4. Calculate amplitude. Amplitude = (Turn Off - Turn On). An amplitude of more than 40°F may indicate a problem with heat source. For example, poor combustion, see combustion analysis.
5. Calculate average. Actual average = (Turn On + Turn Off) divided by 2. Variance (between actual average and programmed setpoint) of greater than 5 degrees indicates that adjustment is needed.
6. To adjust: CONFIGURATION MODE (1972) ELECTRIC
 - A. Enter mode, scroll temperature knob to P24. Turn humidity knob to enter offset.

NOTE: Turn humidity knob *clockwise* for positive offset, to *lower* overall cavity temperature.

NOTE: Turn humidity knob *counterclockwise* for negative offset, to *raise* overall cavity temperature.

- B. If actual average temperature is higher than programmed setpoint, enter a positive offset value of same amount. (For example, if oven is cycling around an actual average of 360°, adjust by entering an offset of +10°.)
- C. If actual average temperature is lower than programmed setpoint, enter a negative offset value of the same amount. (For example, if oven is cycling around an actual average of 340°, adjust by entering an offset of -10°.)

- 1) The offset can be adjusted + or - 30°, but is only functional within the operating limits of the oven. Factory setting is 0.
7. To save setting, exit configuration mode by turning temperature knob back to "----" (idle mode) and listen for beep.
8. To recall offset value, enter CONFIGURATION MODE (1972) ELECTRIC, turn temperature knob to P24. Verify the value set is visible in humidity.

EXTERNAL MEAT PROBE THERMOCOUPLE CALIBRATION

NOTE: ABCx-xxxP devices only.

1. Place end of probe into slurry of ice and water.
2. Insert probe into socket on front panel of oven.
3. Log into CONFIGURATION MODE (1972) ELECTRIC.
4. Check probe temperature by turning temperature knob clockwise to P21.
 - Timer display should read PCAL.
 - Humidity display should read 0, (default zero offset).
5. Calibrate probe (P21).
 - A. Turn timer knob clockwise to view current calculated probe temperature.

NOTE: Calculated probe temperature is TC2 input with P21 applied.

- B. Turn humidity knob clockwise or counterclockwise to adjust offset (-10 through +10) until timer display matches the input.

NOTE: Timer display reads 32 with ice water input.

- C. Exit out of configuration mode 1972.

CAVITY VENT SWITCH TEST AND ADJUSTMENT

Y10 TEST

Y10 test measures motor current, conditions of two vent switches and time it takes for the two switches, to indicate a change for the vent. Each time the test runs, the motor should turn ¼ of a turn. A ¼ turn is what it takes to make the vent to go from fully closed to fully open, or from fully open to fully closed. It is recommended this test be ran eight times so the motor

will go through 2 full cycles. If no errors are encountered, vent switches and vent motor are operating properly.

1. Go into SERVICE MODE (1963).
2. Turn temperature knob until Y10 comes on display.
3. Turn humidity knob one step clockwise.

NOTE: Test will take about 15 seconds.

NOTE: Timer display will go from (VEnt / CLSd, to SPin / = 5, to VEnt / oPEn) or (VEnt / oPEn, to SPin / = 5, to VEnt / CLSd).

4. If test ran successfully, turn humidity knob one detent clockwise to run test again. Complete test eight times.

If an error occurs:

- Timer display shows "Err" means vent switches are in an error state and need adjusted or replaced.
- Timer display shows "=Err" means vent motor did not draw current.
- After 75 seconds, if vent switches do not indicate a ¼ turn has been made, the humidity display will show "Err".

Cavity Shaft Set Screw Adjustment



⚠ WARNING

Disconnect the electrical power to the machine and follow lockout / tagout procedures.

1. Turn damper camshaft by hand.
 - If damper camshaft is loose, continue to next step.
 - If unable to turn by hand, refer to VENT SWITCH ADJUSTMENT; cavity shaft does not need adjusted.

2. Remove motor.

NOTICE

Removing motor allows you to locate the flat on the shaft to tighten set screw on.

3. Spin shaft to locate flat.
4. Install motor.
5. Rotate shaft to locate set screw over the flat on shaft.
6. Tighten set screw.

7. Perform Y10 test in Service Mode.

VENT SWITCH ADJUSTMENT



WARNING

Disconnect the electrical power to the machine and follow lockout / tagout procedures.

1. Loosen screws securing vent to the frame (by 1/4 turn) to allow top of switches to be adjusted in or out.



Fig. 104

2. Remove wires 44, 45, 46, and 47 from vent switches

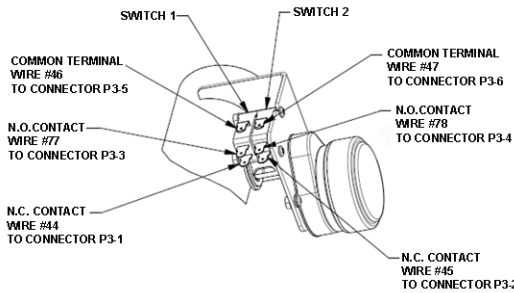

Fig. 105

3. Rotate damper camshaft (using a pair of channel locks) until indicator on the end of the camshaft is at diagonal (Fig. 106).

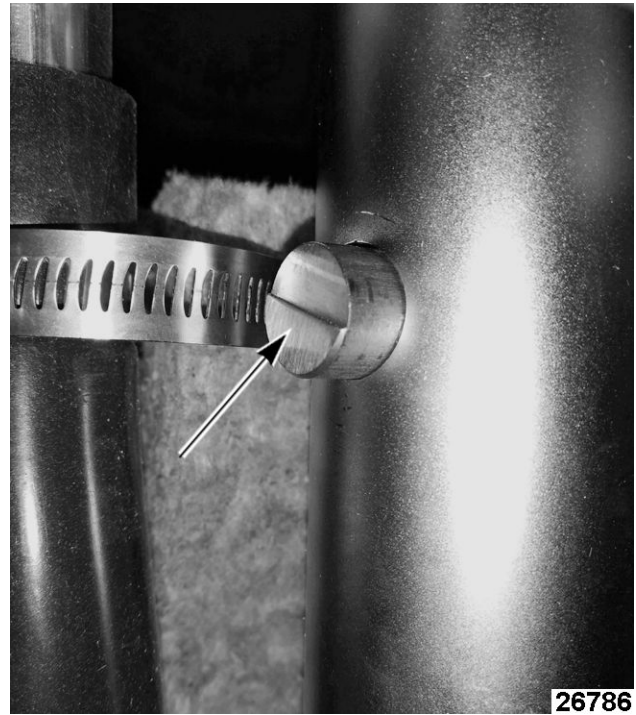

Fig. 106

4. Connect a meter set to check resistance to the common terminal and N.C. contact of switch 1.
- NOTE:** If meter reading indicates an open, pull top of switch away from camshaft. If meter reading indicates continuity, continue to next step.
5. Press top side of switches towards camshaft until meter indicates an open.
 6. Tighten screws securing switches.
 7. Use meter to check the common terminal and N.C. contact of both switches. Both switches at this point should read open.
 8. Perform a quick check.
 - A. Connect a meter set to check resistance to the common terminal and N.C. contact of switch 1.
 - B. Rotate damper camshaft through one revolution using channel locks.
 - C. During one revolution of the Cam shaft, the meter should indicate continuity at two different spots. These two spots should be 180° from each other.
 - D. Repeat this check for switch 2.
 9. Reconnect wires to both vent switches.
 10. Reattach panels.

DOOR TO CONTROL PANEL ALIGNMENT

Alignment Checks

1. Visually check to see if control panel (1, Fig. 108) is flush with the frame (2, Fig. 108) of the oven along the top (Fig. 107) and side. **Not** with the top trim (3, Fig. 108).

Front/Top View



Fig. 107

Side View

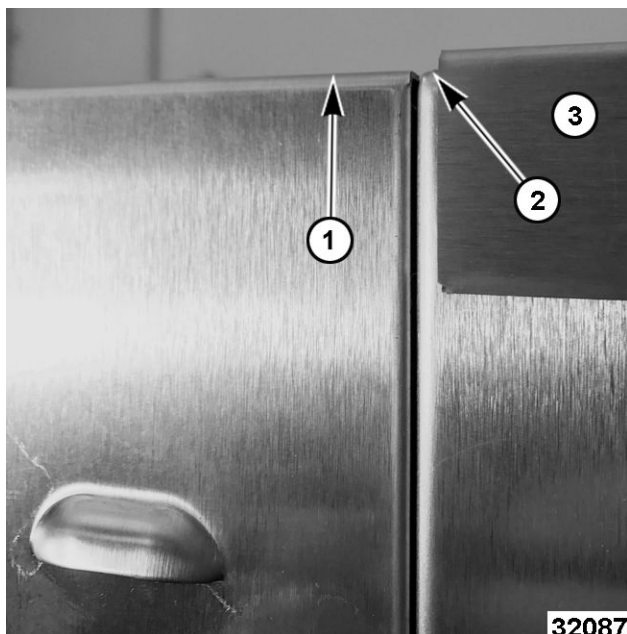

Fig. 108

2. Verify door alignment to control panel with straight edge.



Fig. 109

3. Verify door spacing is correct.
 - A. Insert the Go gauge (.119") above and below plunger within the black handle bezel area.

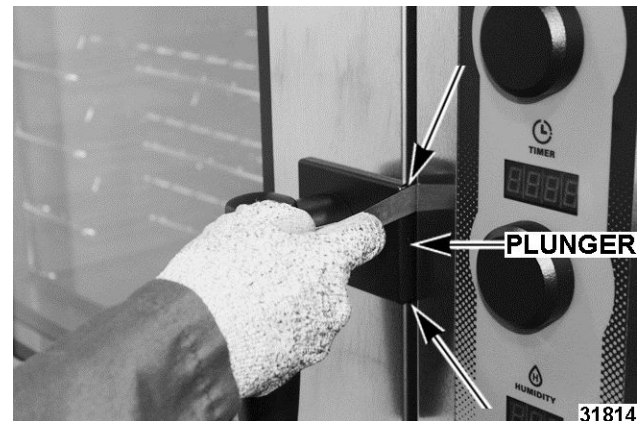

Fig. 110

- B. Insert No-Go gauge (.200") above and below plunger within the black handle bezel area.
4. If oven failed any alignment checks, do the following adjustments.
 - Visual alignment check of the control panel failed, perform Control Panel Adjustment.
 - Visual alignment check of the door failed, perform Door Adjustment.
 - Go/No-Go gauge check failed, perform Door Adjustment.

NOTICE

All three alignment checks must pass before checking door operation.

5. Verify door operates correctly.
 - A. Check that the door comes to about an inch from closing before it compresses gasket.
 - B. Verify door closes without slamming.
 - C. Handle should turn smoothly with little effort to unlatch.

Control Panel Adjustment



WARNING

Disconnect the electrical power to the machine and follow lockout / tagout procedures.

1. Remove right panel.
 - A. Remove four right panel screws.
 - B. Lift right panel up and back using handles.

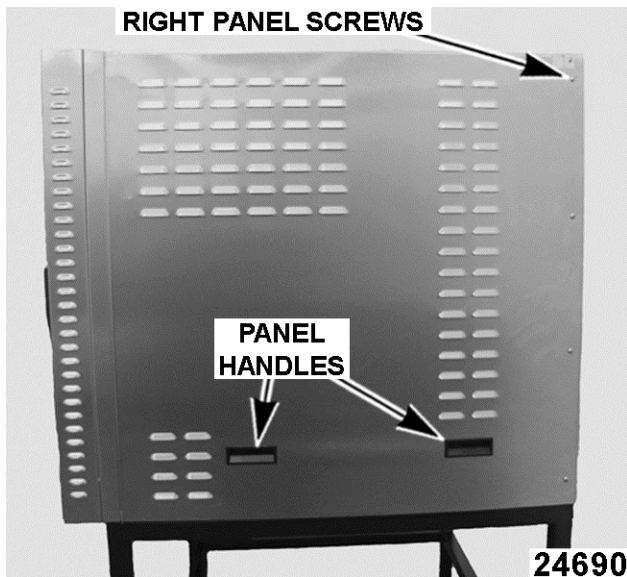

Fig. 111

2. Slightly loosen six screws securing control panel.



Fig. 112

NOTE: Only loosen screw enough that the alignment of the control panel can be adjusted with some effort.

3. Adjust the control panel (1, Fig. 114) until it is flush with the frame (2, Fig. 114) of the oven along the top (Fig. 113) and side. Not with the top trim (3, Fig. 114).

Front/Top View



Fig. 113

Side View

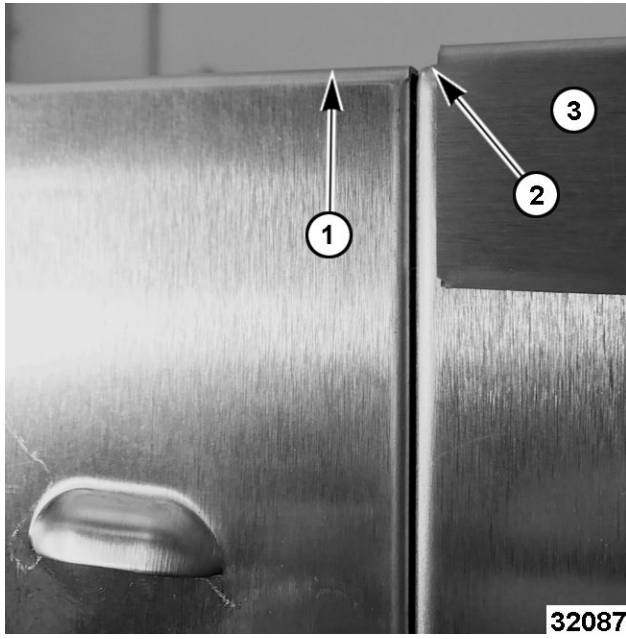

Fig. 114

4. Tighten screws securing control panel at 24 in. lbs.
5. Repeat all three Alignment Checks.

Door Adjustment

1. Loosen top and bottom hinge screws slightly to allow door to move.



Fig. 115

2. Adjust door (1, Fig. 116) so top is flush with control panel (2, Fig. 116).

NOTE: Keep in mind you must keep the proper distance between the door and control panel (3, Fig. 116) for Go/No-Go gauge to pass.



Fig. 116

3. Tighten door hinge screws at 75 in. lbs.
4. Repeat all three Alignment Checks.

DOOR SWITCH ADJUSTMENT

1. In SERVICE MODE (1963), run S6 Door test.

NOTE: If the door test reports that the door is open when it is closed it may be because the door reed switch is not lined up with the magnet in the door.

To adjust the door reed switch:



WARNING

Disconnect the electrical power to the machine and follow lockout / tagout procedures.

- A. Remove RIGHT PANEL.
- B. Remove CONTROL PANEL.

- C. Loosen screws and nuts to adjust and obtain dimensions as shown in Fig. 117.

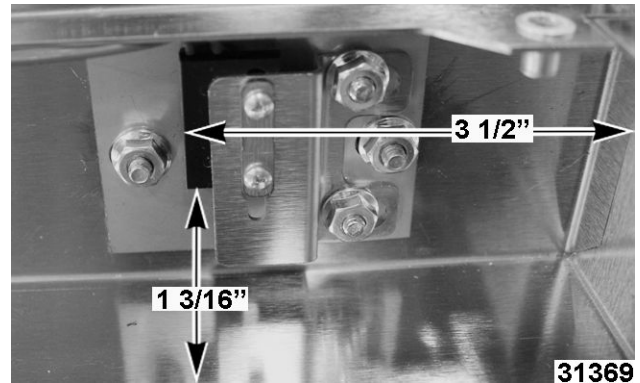

Fig. 117

- D. Verify wire location as shown in Fig. 118.



Fig. 118

TRANSFORMER RESISTANCE CHECK



WARNING

Certain procedures in this section require electrical test or measurements while power is applied to the machine. Exercise extreme caution at all times and follow Arc Flash procedures. If test points are not easily accessible, disconnect power and follow Lockout/Tagout procedures, attach test equipment and reapply power to test.

1. Unplug both primary and secondary side of transformer.
2. Measure resistance at both plug connections.
3. Verify resistance is $\pm 10\%$ for each reading. Refer to [Fig. 120](#).

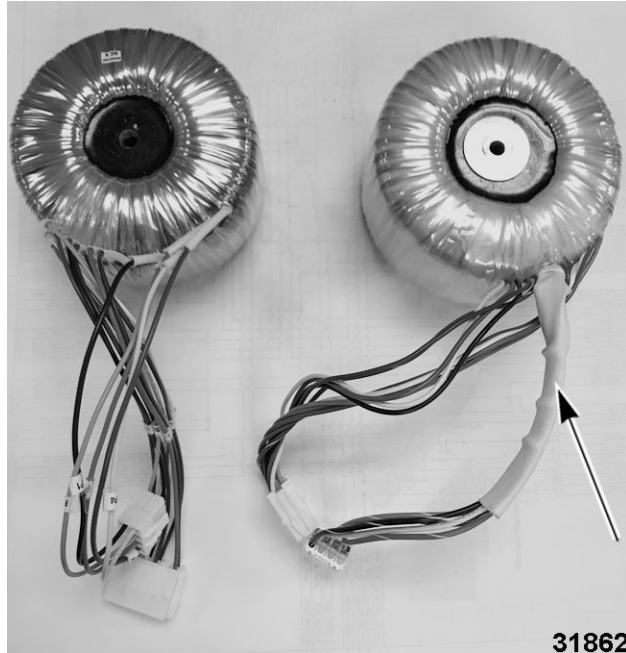
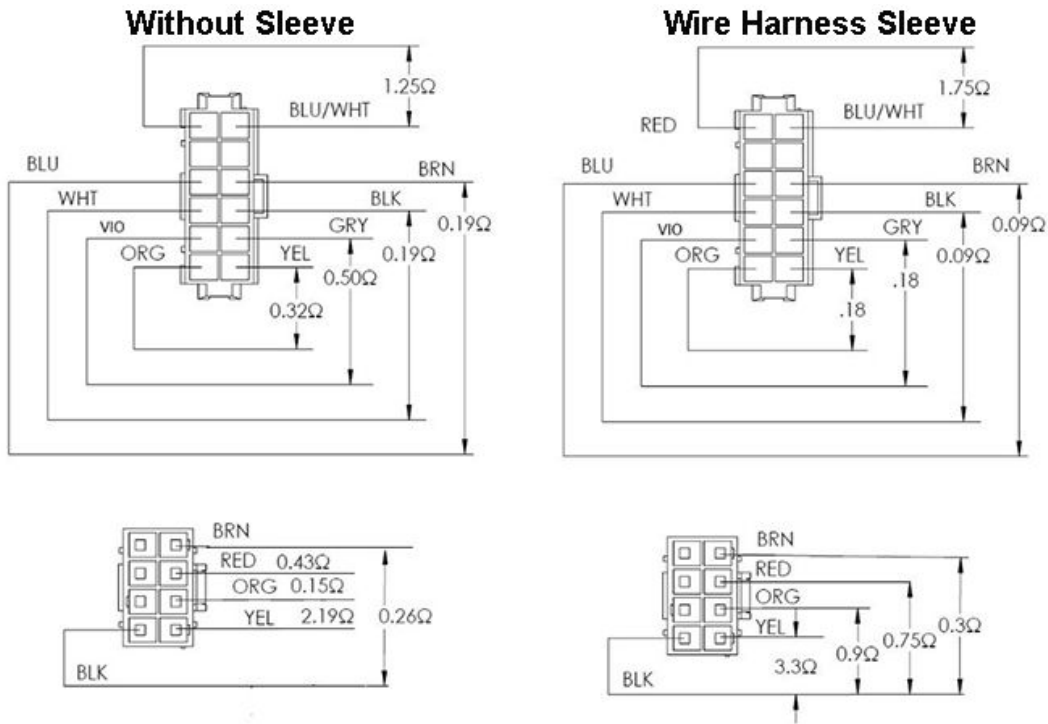

Fig. 119

NOTICE

There are two types of transformers, one with a wire harness sleeve and one without. Use the proper diagram for the transformer you are servicing in [Fig. 120](#).



31864

Fig. 120

MOTOR RESISTANCE CHECK



WARNING

Certain procedures in this section require electrical test or measurements while power is applied to the machine. Exercise extreme caution at all times and follow Arc Flash procedures. If test points are not easily accessible, disconnect power and follow Lockout/Tagout procedures, attach test equipment and reapply power to test.

1. Remove REAR PANEL.
2. Note and disconnect motor wires (1, Fig. 121) at TB2.

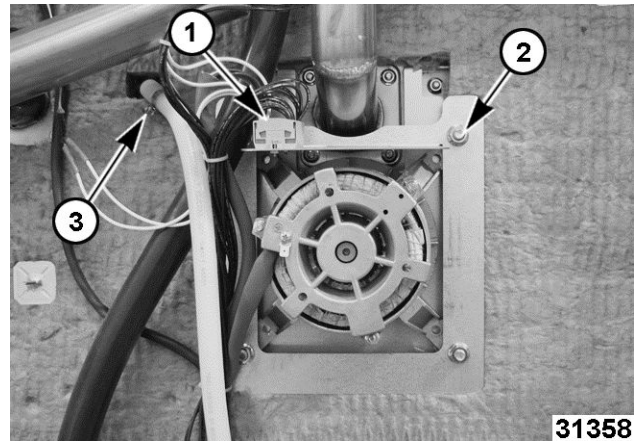

31358

Fig. 121

3. Measure resistance.

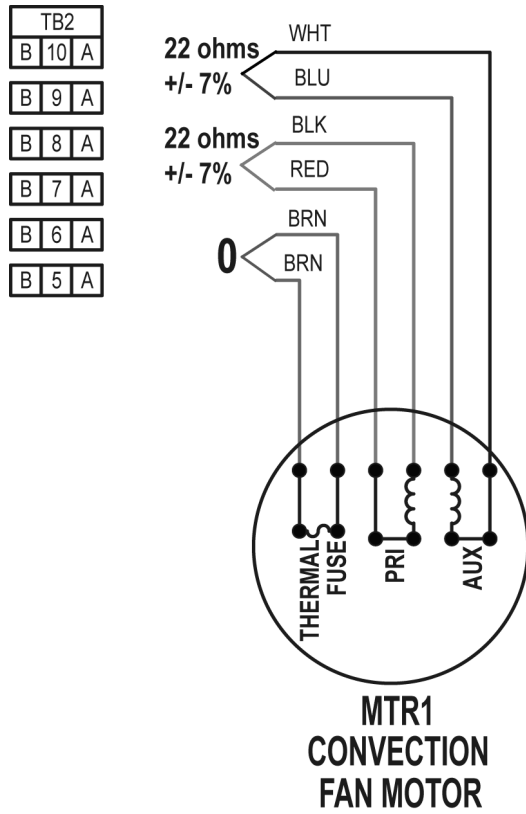

AI4758

Fig. 122

4. Reconnect motor wires to TB2.
5. Install REAR PANEL.
6. Verify proper operation.

HEATING ELEMENTS RESISTANCE CHECK



WARNING

Disconnect the electrical power to the machine and follow lockout / tagout procedures. There may be multiple circuits. Be sure all circuits are disconnected.

NOTE: There are two sets of Heating Elements (E1 - Inner) and (E2 - Outer), each set is made up of three individual elements.

NOTE: The element resistance can be measured on the load side of the contactors with wires in place when no voltage is present.

1. Remove SIDE PANEL.
2. Measure element resistance at contactor terminals (K2-T3 and K4-T1), (K2-T2 and K4-T3) and (K2-T1 and K4-T2) to check the three elements making up the inner set.
3. Measure element resistance at contactor terminals (K1-T3 and K3-T1), (K1-T2 and K3-T3) and (K1-T1 and K3-T2) to check the three elements making up the outer set.

NOTE: If resistance is out of range, measure element resistance directly at the elements.

Measure Element Resistance Directly at Elements

1. Remove REAR PANEL.
2. Remove rear cooling fan to access elements.
3. Note and disconnect element wires.
4. Measure between terminals (E1-1 and E1-6), (E1-2 and E1-5) and (E1-3 and E1-4) to check three elements making up inner set.
5. Measure between terminals (E2-1 and E2-6), (E2-2 and E2-5) and (E2-3 and E2-4) to check three elements making up outer set.
6. Install rear cooling fan.
7. Refer to HEATING ELEMENTS to install heating element wires.
8. Verify proper operation.

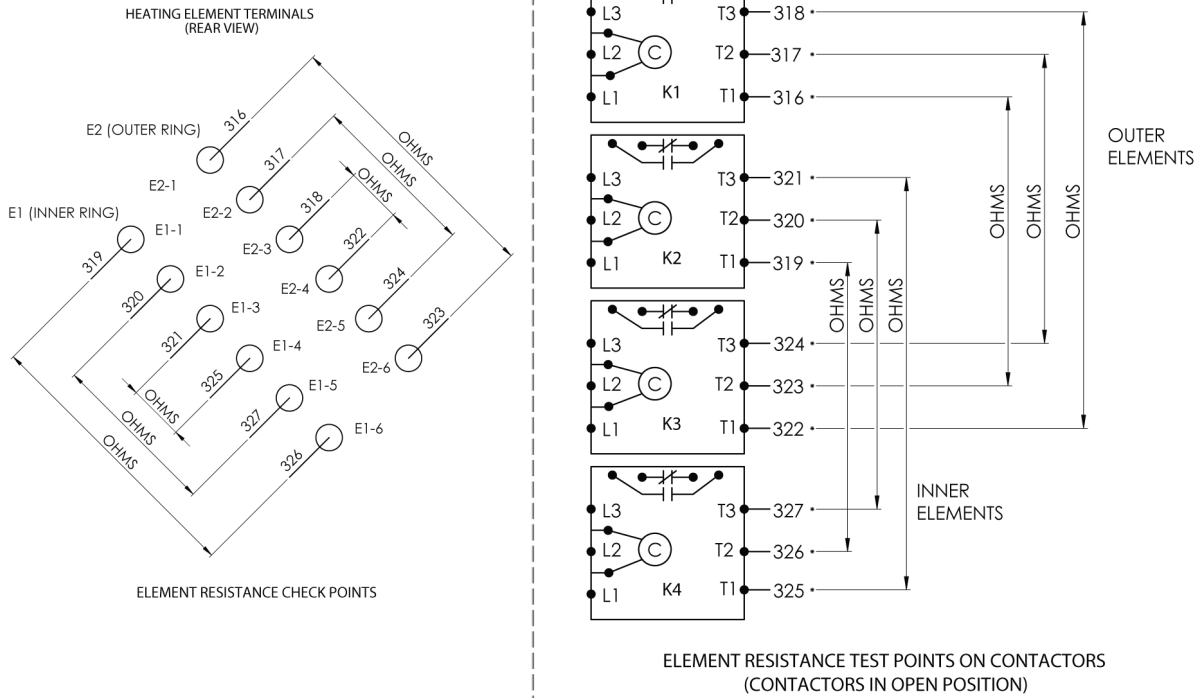

DERIVED FROM 00-973730

AI3685

Fig. 123

Element Voltage	Resistance Measurement
208 / 240 Volts	14 Ohms ± 2 Ohms
480 Volts	55 Ohms ± 5 Ohms

ELECTRICAL OPERATION

COMPONENT FUNCTION

Main Board	Manages all input/output functions of oven as required for combi cook operation. Monitors oven temp RTD probe, and outputs call for heat to contactors. Monitors oxygen sensor board and outputs to humidity valves. Monitors condensate tempering thermocouple probe and outputs to condensate valve, monitors door switch and controls cavity lights. Outputs to motor control board to control speed and direction of Convection Fan motor. Rotates the cavity vent intake damper from open/closed using the cavity vent motor output and two cavity vent switch inputs. Monitors on/off switch to change operator interface from sleep/wake mode. Enables cooling fans. Monitors the display board for customer input from knobs, and sends time, temperature, and humidity information to display board. Monitors N.O. Aux contactor contacts for high limit errors and monitors oxygen board and motor board for oxygen sensor and convection fan motor errors.
Display Board	Processes signals from each encoder mounted to each of the three control knobs. Then sends signal to Main board. Processes input signals from Main board to refresh displays with Time Temperature and Humidity cooking information.
Motor Control Board	Low voltage portion of the board processes drive signal (amber LED) and reverse signal (green LED) from the Main board to control an on board reversing relay and external solid state relay. The reversing relay contacts on the high voltage side of the board reverses voltage phases to change the motor rotation direction; The solid state relay wired to the motor board, power the convection fan motor. The motor neutral phase is daisy chained with convection fan motor's thermal fuse and F7 motor current protection fuse at the motor board. The motor board's current sense circuit monitors the current through the fuses and sends a low voltage signal back to the main board (viewed on the RED LED) on the low voltage side. The current sense circuit is also responsible for detecting E1 and E6 errors.
Encoders (SW7,SW8,SW9)	Optically coupled rotary encoder switch that is mounted behind the control knob and sends signal to display board as knob is turned in any direction, or is pushed.
Oxygen Board	Heats and controls the oxygen sensor, and reports back oven cavity humidity information to the Main board. Also receives calibration command from Main board.
Oxygen Sensor (SW5)	Measures the amount of humidity in the oven cooking cavity and is controlled by the Oxygen Sensor Board.
Door Switch (SW3) ...	Magnetic reed switch senses the presence of the magnet in the door and closes. Monitored by the main board, which starts stops the cook cycle and activates the lights based on the state of the door switch.
ON / OFF Switch (SW4)	Is a toggle switch that is monitored by main board to put unit from sleep to cooking idle mode. It provides 230 VAC to the following relays on the main board: cavity vent motor, high and low humidity valve, condensate tempering valve, cooling fans.
Transformer (T1)	Transformer with 480, 240 or 208 VAC inputs. Multiple secondary voltages as follows: 230 VAC to motor board and convection fan motor, vent motor, all water solenoids and cooling fans. 12 VAC to oxygen board and oxygen sensor. 12 VAC to cavity lamps. 24 VAC to main board, motor board, vent switches, door switches high limit sensing contacts
Terminal Block (TB1)	Incoming voltage supply connection from 20A fuses (F5 and F6). Transformer to 230 VAC connections.
Terminal Block (TB2)	Convection Fan Motor (MTR1) and Temperature Sensor (RTD1) connections.

Terminal Block (TB3)	Incoming voltage supply line (480, 240 or 208) to contactors (K1, K2, K3, K4) and to fuses F5 and F6. Configure for either 3 Phase or single phase.
Terminal Block (TB4)	Low voltage outputs from transformer connection.
Fuse (F1)	4A - Protects 12 VAC oven Oxygen Sensor Board circuit.
Fuse (F2)	4A - Protects 12 VAC oven Cavity Light circuit.
Fuse (F3)	4A - Protects 24 VAC Main Board, Motor Board, Vent Switches, Door Switches, High Limit Sensing Contacts.
Fuse (F5)	20A fuse to transformer primary.
Fuse (F6)	20A fuse to transformer primary (Common).
Fuse (F7)	6.25A fuse - motor current protection fuse. F7 protects from a malfunction of the motor control boards on board reversing relay.
Fuse (F8)	5A fuse. Protects Oxygen Sensor Board. (Mounted on Oxygen Sensor board).
Oven Door Lights (L1, L2, L3)	Provides light for the oven cavity (located in door frame). Voltage to light circuit (12 Volt, 5 Watt Bulbs).
Cavity Vent Motor (MTR2)	Controls the oven cavity vent intake damper inside the cavity vent intake tube.
Cavity Vent Open (SW1)	Reports the position (open/closed/spin) of the cavity vent intake damper. Works in conjunction with SW2.
Cavity Vent Closed (SW2)	Reports the position (open/closed/spin) of the cavity vent intake damper. Works in conjunction with SW1.
Humidity Valve Cavity (Low Flow) (SOL2)	Admits water into the injection nozzle (in a slow stream) that drips onto water atomizer to vaporize the water droplets and provide steam for combi mode or cool the oven temperature.
Humidity Valve Cavity (High Flow) (SOL3) ...	Admits water into the injection nozzle (in a slow stream) that drips onto water atomizer to vaporize the water droplets and provide steam for combi mode or cool the oven temperature
Cooling Fans (CF1, CF2, CF3)	Circulate air through the oven control panel, display panel, and convection fan motor area for component cooling.
Convection Fan Motor (MTR1)	Circulates air through the oven cavity. Driven by motor control board, through capacitor C1. Reverses direction at programed intervals.
Oven Sensor Input (RTD1)	Senses oven cavity temperature and sends the data to the Main board.
High Limit (TS1)	Removes power from element safety contactors K1 and K2 if oven cavity overheats. The status of the High Limit is sent to the main board by aux contacts on K1.
Cold Water Condensate (SOL1) ...	Admits water to p-trap on power up to seal oven cavity. Admits water p-trap to mix with drain water to cool drain discharge water to 140°F before exiting oven.
Drain Water Sensor Input (TC1)	Monitors drain water temperature and is monitored by Main board.
External Meat Probe Thermocouple Input (TC2)	Monitors food product temperature. Monitored by the main board when external probe is plugged into socket on front panel, then inserted into food product (units with probe).
Motor Interlock Relay (R1)	Removes 230 VAC to the motor control board when the On/Off switch is Off.

- Heat Interlock Relay (R2)** Is used to disable the call for heat signal from the main board to the contactor coils of K3 and K4 when On/Off switch is off.
- Contactor (K1)** Safety Outer. Provides voltage to outer heating elements. Removes voltage when high limit is tripped.
- Contactor (K2)** Safety Inner. Provides voltage to inner heating elements. Removes voltage when high limit is tripped.
- Contactor (K3)** Hi Heat Outer. Provides voltage to the outer heating element and is controlled by the high heat relay on main board.
- Contactor (K4)** Contactor Low Heat Inner. Provides voltage to the inner heating element and is controlled by the low heat relay on main board.
- Oxygen Board Interlock Relay (R3)** Removes power to the oxygen board and sensor when the On/Off switch is Off.
- Fan Motor Relay (R6)** Solid State Relay used to drive the convection fan motor. Is controlled by the motor control board.
- Ferrite** Passive electric component used to suppress high frequency noise from the oxygen sensor board.
-

CONTROL PANEL COMPONENT LOCATIONS

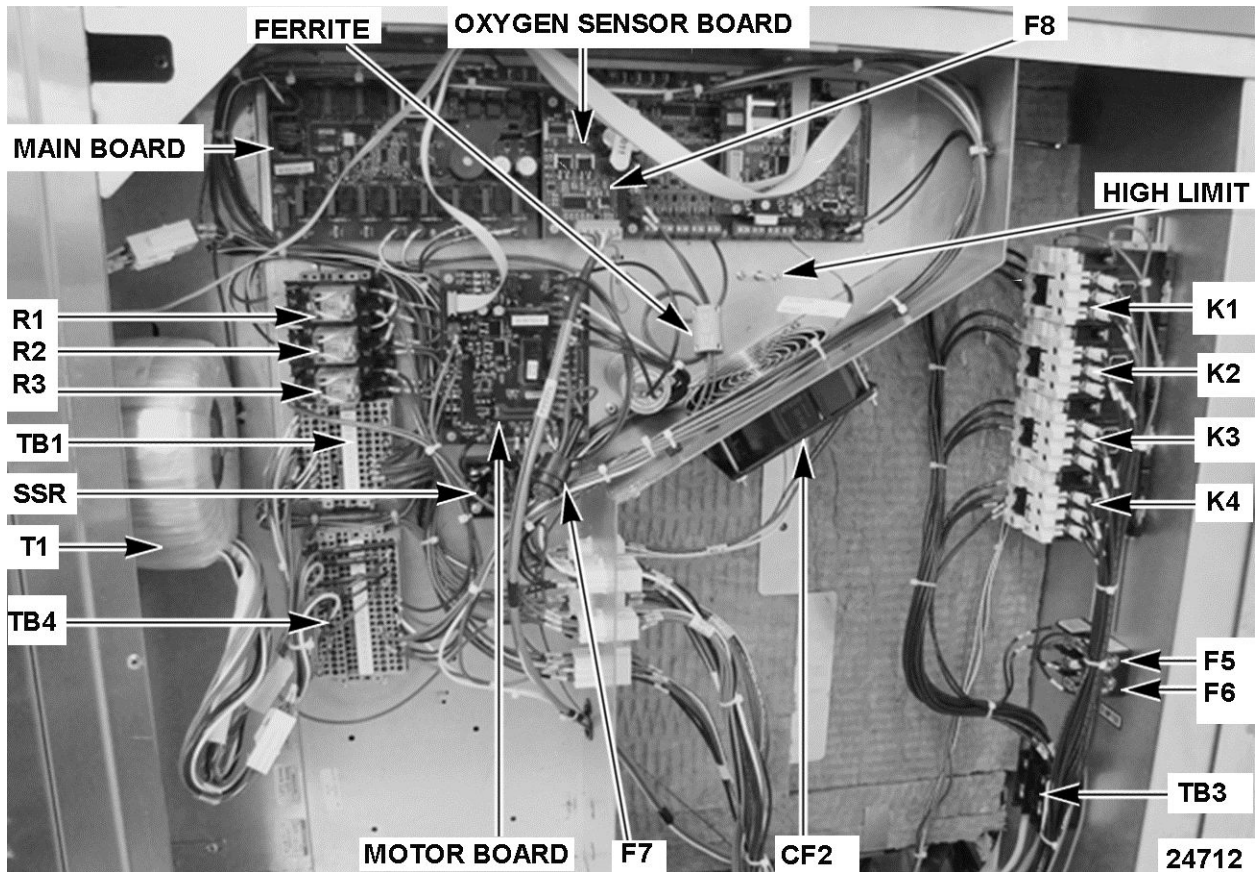

Fig. 124

SEQUENCE OF OPERATION

CONDITIONS

1. Unit plugged into incoming power supply and is properly grounded.
2. ON/OFF switch (SW4) off.
3. Door switch closed (SW3).
4. High limit switch closed.
5. 208 VAC (or 240 VAC or 480 VAC) to TB3 (either 3 phase or 1 phase).
 - A. 208 VAC (or 240 VAC or 480 VAC) as Supply Voltage to:
 - 1) Contactor K1, terminals L1, L2, and L3.
 - 2) Contactor K2, terminals L1, L2, and L3.
 - 3) Contactor K3, terminals L1, L2, and L3.
 - 4) Contactor K4, terminals L1, L2, and L3.
 - 5) Fuse F5 to TB1-10 for 208 VAC, (-11 for 240 VAC), (-12 for 480 VAC).
 - 6) Fuse F6 to TB1-8.
6. Supply Voltage to Transformer T1 (TB1-10, or -11, or -12 and TB1-8) for correct oven voltage on primary input of T1.
 - A. Transformer step up from or down from the Supply Voltage to 230 VAC providing voltage for oven components (solenoid valves, motor board (convection fan motor), vent intake motor, and cooling fans).
 - B. Transformer steps down from Supply Voltage to 24 VAC on two secondaries, 24 VAC and 24 VAC (IM).
 - 1) 24 VAC providing voltage for main board, motor board, vent switches, door switch.
 - C. Transformer steps down Supply Voltage to 12 VAC on two secondaries, 12 VAC (Lite) and 12 VAC (Oxy).
 - 1) 12 VAC (Lite) Light providing voltage for the cavity door lights.
 - 2) 12 VAC (Oxy) providing voltage for oxygen sensor board and oxygen sensor.
7. 230 VAC
 - A. 230 VAC from transformer through TB1-6 and TB1-7 to:
 - 1) On/Off Switch (SW4).
 - 2) Motor Interlock Relay (R1.2) Common contact.
 - 3) V5 on Main Board.
 - 4) High Limit switch (TS1).
 - a. 230 VAC to Contactor K1.
 - b. K1 energizes sending Supply Voltage to one side of (E2) outer heating element (Pins 1, 2, 3).
 - a. 230 VAC to Contactor K2.
 - b. K2 energizes sending Supply Voltage to one side of (E1) inner heating element (Pins 1, 2, 3).
 - B. 230 VAC (Com) from transformer through TB1-2, -3, -4 and -5 to:
 - 1) Cavity Vent (M2).
 - 2) V2 Main Board.
 - 3) Heat Interlock (R2-B).
 - 4) Motor Interlock (R1-B).
 - 5) Interlock relay (R1.1) Common Contact.
 - 6) Cold Water Condensate (SOL1).
 - 7) Humidity Valve Cavity (Low Flow) (SOL2).
 - 8) Humidity Valve Cavity (Hi Flow) (SOL3).
 - 9) Cooling Fans (CF1, CF2, CF3).
 - 10) V4 Main Board (call fro heat common).
8. 24 VAC
 - A. 24 VAC from transformer to TB4-16 through 4A fuse (F3) to:
 - 1) Cavity Vent Switch (SW1-COM).
 - 2) Cavity Vent Switch (SW2-COM).
 - 3) Door Switch (SW3).
 - 4) V9 connection on Main I/O Board.
 - 5) P21 connection on Motor Control/ Reversing Board.
 - 6) Hi Limit sensing K1 auxiliary Contact (COM).

- B. 24 VAC (Com) from transformer to TB4-5 and TB4-6 to:
 - 1) P22 connection on Motor Control/ Reversing Board.
 - 2) V8 connection on Main I/O Board.
- 9. 12 VAC (oxy)
 - A. 12 VAC (oxy) from transformer to TB4 through 4A fuse F1 to:
 - 1) Oxygen board interlock relay COM contact (R3.1).
 - B. 12 VAC (oxy) COM from transformer to TB4 to:
 - 1) Oxygen board interlock relay COM contact (R3.2).
- 10. 12 VAC (lite)
 - A. 12 VAC (lite) from transformer to TB4 through 4A fuse (F2) to:
 - 1) V3 (Lamp) on Main board
 - B. 12 VAC (lite) COM from transformer to TB4 to:
 - 1) Cavity Lamps (L1, L2, L3) COM (Previous Production).
 - 2) Cavity Lamps (L1) COM (Current Production).

**ON/OFF Switch (SW4) turned ON,
(No Call for Heat)**

- 1. Motor Interlock relay coil (R1) energizes.
 - A. Provides 230 VAC across P1 (wire 106) and P20 (wire 107) on Motor Board.
 - B. Convection fan motor (M1) energizes.
- 2. Heat Interlock relay coil (R2) energizes.
 - A. R2.1 closes allowing the Call_For_Heat signal input from the Main I/O board to pass to High Heat relay K3.
 - B. R2.2 closes allowing the Call_For_Heat signal input from the Main I/O board to pass to Low Heat relay K4.
- 3. R3 oxygen sensor board interlock relay coil (R3) energizes.
 - A. Providing 12 VAC (Oxy) to Oxygen Board across J1 (wire 42) and J2 (wire 43).
 - B. **Rev 11 FIRMWARE** (as seen in Service Mode 1963 o2 test).

- 1) D3 (amber), D4 (red), D5 (green) LEDs energized for 2 seconds.
- 2) D3 (amber) LED energized for 3 seconds confirming calibration of electronics on board.
- 3) D4 (red) LED energized for 1-3 minutes while the oxygen board is heating up the oxygen sensor.
- 4) D5 (green) LED blinks indicating transmission of Humidity data from Oxygen sensor board through piggyback connection to Main board.

NOTE: Rev. 11, once in regulation, only the green LED blinks. However, due to sporadic electrical noise, the red LED may intermittently come on indicating undershoot or overshoot of the oxygen sensor's heater function (hysteresis). If this condition lasts longer than 60 seconds, condition is logged, E16.

- C. **Rev 12 FIRMWARE** (as seen in Service Mode 1963 o2 test).
 - 1) D3 (amber), D4 (red), D5(green) LEDs energized for 2 seconds.
 - 2) D5 (green) LED energized for 3 seconds confirming calibration of electronics on board.
 - 3) D3 (amber) LED (Rev. 12 firmware energized for 1-3 minutes while the oxygen board is heating up the oxygen sensor.
 - 4) D5 (green) LED blinks indicating transmission of Humidity data from Oxygen sensor board through piggyback connection to Main board.

NOTE: Rev.12, once in regulation, only the green LED blinks. However, due to sporadic electrical noise, the amber LED or the red LED may intermittently come on indicating undershoot or overshoot of the oxygen sensor's heater function (hysteresis). If this condition lasts longer than 60 seconds, the condition is logged, E22-28.

- 4. 230 VAC to V1 on Main board.
 - A. Main I/O board sends Control signals through the ribbon cable to display board and illuminates the Temp (---) Time (--:--) and humidity (---) displays (---).
 - B. Y6 energizes the 3 cooling fans. (CF1, CF2 and CF3).

- C. Y9 energizes the cold water condensate Valve (SOL1) to fill the p-trap for 6 seconds so cold air does not get sucked up into the cooking cavity through the drain.
- D. Y10 Cavity Vent Intake motor (MTR2) energizes to close the vent (if previously open).
- E. Main board monitor SW1 and SW2 for the closed position, and de-energizes Y10, cavity vent intake motor.
- F. Y13 energizes turning on the cavity lamp(s).

NOTE: Newer construction energizes one 10W lamp (L1). Older construction energizes three each, 5W lamps (L1, L2, L3).

ON/OFF Switch (SW4) ON & with Call for Heat

- 1. Temperature knob turned, to enter Temperature setpoint. Sending signal from SW7 encoder to Main I/O board through the ribbon cable (for example 350°F).

NOTE: Timer (SW8 input) has no effect on the call for heat. No timed cooking.

Motor Control Board

- 1. Main I/O board sends controls signals through the ribbon cable to the motor board.
- 2. Amber colored LED turns on to indicate that a drive signal is being sent to the external solid state relay.
- 3. Green colored LED indicates the direction of the motor and toggles its state from on to off (or off to on) every 2 minutes during a cooking cycle.

NOTE: The state of the onboard reversing relay changes every two minutes (as indicated by the green led). This reverses the phases of the motor to reverse the direction of the motor.

- 4. Red LED indicates the presence of current in the convection fan motor, and signals the main I/O board through the ribbon cable.
- 5. The Solid State Relay (R6) energizes continually at default fan speed.

NOTE: Default convection motor fan speed is: F3, maximum.

- 6. Convection Fan Motor (MTR1) energizes.

HI /LO HEAT OPERATION

- 1. Y14 Call for heat low relay energizes on main board.

NOTE: On the initial call for heat, a software counter begins to measure "call_4_heat" on time (see Overshoot Feature).

- 2. Contactor K4 energizes providing supply voltage to inner elements (E1), pins 4, 5, and 6.

NOTE: Inner elements begin to heat since K2 is already energized.

- 3. Y15 Call for heat high relay energizes on main board.
- 4. Contactor K3 energizes providing supply voltage to outer elements (E2), pins 4, 5, and 6.

NOTE: Outer elements begin to heat since K1 is already energized.

5. Rate of Rise Check

- A. Cavity temperature probe (RTD1) is monitored by the main board at xa1 and xa2, and turns off the call for heat (both high and low) when cavity temperature on RTD1 is satisfied (same as setpoint on SW7 encoder).

- 1) During the initial heating cycle, the rate of temperature rise is checked. As temperature rises, at setpoint - 15°, if the temperature is rising faster than 2° per second, both heating elements call for heat (Y14 and Y15) are turned off before the RTD1 temperature is satisfied. This is done to prevent too big of a temperature overshoot.

The "initial heating cycle" is defined as the first time the control board calls for heat after:

- a. First time a temperature setpoint is entered in cook mode.
 - When temperature is set from "----".
 - When the On/Off switch is toggled and temperature setpoint is automatically recalled.
- b. When it is detected that the door goes from being opened to closed in cook mode.

Overshoot Feature

- A. When trays of frozen product are placed in the oven, and the oven is recovering up to setpoint, the temperature in the center of the oven and the temperature in the upper corner where the temperature probe is

located are going to be different. To make up for this, the first time the oven tries to reach setpoint, the control board will keep calling for heat until the temperature at the cavity temperature probe is 50°F higher than the setpoint (“augmented setpoint”). This feature automatically kicks in if the following conditions exist.

- 1) The temperature setpoint is higher than 250°F.
- 2) It takes longer than 8 minutes to reach setpoint.
- 3) This must be the “first call for heat cycle”.

The “first call for heat cycle” is defined as the first time the control board calls for heat after:

- a. First time a temperature setpoint is entered in cook mode.
 - When temperature is set from “---”.
 - When the On/Off switch is toggled and temperature setpoint is automatically recalled.
 - b. When the temperature setpoint is changed.
 - c. When it is detected that the door goes from being opened to closed in cook mode.
6. Y15 call for heat relay (high) is de-energized on main board.
 - A. K3 contactor opens.
 - B. Voltage removed from outer heating elements.
 7. Y14 call for heat relay (low) is de-energized on main board.
 - A. K4 contactor opens.
 - B. Voltage removed from inner heating elements.
 8. Subsequent Cycles.
 - A. When temperature as monitored by RTD1 drops 1° below the setpoint on SW7 encoder.
 - 1) Y14 low heat only turns back on.
 - B. If temperature continues to fall and reaches setpoint - 15°.

- 1) Y15 high heat turns back on to assist.

NOTE: If the temperature does not fall 15° below setpoint, the oven will regulate on the low heat inner elements only.

NOTE: The high heating element control relay is never turned on without the low heat element control relay being turned on.

- C. When RTD1 is satisfied (at setpoint) both Y14 and Y15 are turned off by main board.

ON/OFF Switch (SW4) ON & with Call for Heat & Call for Humidity

Humidification Sequence

1. Humidity knob automatically changes to the mapped humidity for that setting, or humidity knob can be changed by the user (SW9 input).
2. Humidity knob sending signal from SW9 encoder to Main I/O board through the ribbon cable (for example 70%).
3. After Main I/O board senses the cavity temperature on RTD1 is within 50°F of setpoint.
4. Y8 Low humidity water valve, SOL2, energizes.
5. For Humidity Setpoint = 100%, firmware 4-24-17 and later.
 - A. Y8 Low humidity water valve remains energized continually without regulation, as long as cavity temperature does not fall below 50°F of setpoint, or does not fall below 50°F of augmented setpoint. See overshoot feature.
6. For Humidity Setpoints 0- 99%, firmware 4-24-17 and later (or for Humidity Setpoints 0-100%, firmware 8-11-14, 2-25-14).

NOTE: All humidity setpoints between 90% and 99% are treated as 90%.

NOTE: If the oxygen sensor is not functioning (error codes E16, E22-E23, E25-E28), oven will enter a “limp along mode” and will steam in an inefficient open loop mode at setpoints between 212°F and 220°F, and/or humidity setpoints of 100% and will steam with both water valves (Y8, SOL2 & Y5, SOL3) energized continually without regulation.

- A. Y5 High humidity water valve, SOL3 energizes.
- B. Main I/O board monitors oven humidity oxygen sensor, SW5. Then when humidity is satisfied, SW5 = setpoint.

- C. Y5 Humidity high water valve off.
- D. Y8 Low humidity water valve off.

Regulation

- 1) When oven humidity sensor,
SW5 < setpoint – 10%. Y8 Low humidity water valve, SOL2, re-energizes.
- 2) And if oven humidity sensor < setpoint -20%. Y5 High humidity water valve, SOL3 re-energizes.
- 3) Y5 Humidity high water valve off.
- 4) Y8 Low humidity water valve off.

Hysteresis - Cavity vent intake motor (during cook cycle).

NOTE: Humidity Setpoints = 100%, firmware 4-24-17 and later, or Humidity setpoint = "----" if so programmed in P28 CONFIGURATION MODE (1972) ELECTRIC.

- 1. Y10 energizes to close vent (until Main I/O board detects SW1, SW2 closed position).
- 2. Y10 de-energizes and vent remains closed during cook.

NOTE: Humidity Setpoints 0 - 99%, with firmware 4-24-17 and later (or Humidity Setpoints 0-100%), with firmware 8-11-14, 2-25-14.

- 1. Main I/O board monitor oven humidity oxygen sensor, SW5, and compares it to humidity setpoint.
- 2. Y10 energizes to open the vent (until Main I/O board detects SW1, SW2 open position) when oxygen sensor, SW5 > Setpoint +10%.

Example

If Setpoint = 70%, if actual humidity is 80%, then open vent.

- 3. Y10 energizes to close the vent (until Main I/O board detects SW1, SW2 closed position) when oxygen sensor SW5 < = Setpoint.

Example

If Setpoint = 70%, if actual humidity is 70%, then close vent.

Automatic Venting

- 1. When Timer counts down to 30 seconds (defined in P17), then the vent will be opened to release steam in the cavity prior to the presumed opening of the door when the timer expires.
- 2. Y5 Humidity high water valve off.

- 3. Y8 Low humidity water valve off.
- 4. Y10 Cavity Vent Intake motor (MTR2) energizes.
- 5. Main I/O board monitors SW1 and SW2 for the open position, and de-energizes Y10, cavity vent intake motor.

OTHER SEQUENCES

Timer Expires (All ABC devices) AND Cook to Probe Temperature satisfied (ABCx-xxxP devices only)

- 1. Timer sends a signal from SW8 encoder to Main I/O board through the ribbon cable to
- 2. Main I/O Board either:
 - Counts down the time.

NOTE: Timer does not count down when door is open.

OR

- Monitors temperature on external meat probe thermocouple (TC2).
- 3. Main I/O board turns off humidity water valves Y5 and Y8 (turns off steam) typically 30 seconds before timer expires (programmed by P17 in CONFIGURATION MODE (1972)).
- 4. Main I/O board energizes on board buzzer for 5 seconds (or continuously if so programmed in P8 in CONFIGURATION MODE (1972)). Display lights flash.
 - A. Buzzer stops when additional time/cook-to-temperature is added (turn timer knob right).
 - B. Buzzer function is muted when the knob is turned left with door shut. Display lights will still flash.
 - C. Opening the door stops the time and buzzer function.
- 5. Timer function (or cook-to-probe function) does not control or affect heating. Oven will continue to heat, (without humidity) after timer expires (or after cook to probe) temperature has been reached.
- 6. Humidity Function not re-enabled until timer is reset and/or door is opened and closed.

Door Open (SW3 open)

- 1. Y14 call_for_heat_low is off.
- 2. Y5 Humidity high water valve off.
- 3. Y8 Low humidity water valve off.

NOTE: At any time during operation, if door is opened, the cook timer pauses.

Electronic Motor Break (When door opens)

- A. Main board sends controls signals through ribbon cable to motor board.
- B. Amber (L1) and red (L3) LEDs turn off.
- C. The Solid State Relay (R6) de-energizes.
- D. Green colored LED (L2) indicates direction of motor and toggles its state from on to off, or off to on.
- E. Amber colored LED (L1) pulses (faint glow) to indicate that a break signal is being sent to the external solid state relay.
- F. Solid state relay (R6) pulses.
- G. Convection fan motor (MTR1), electronically breaks.
- H. Amber (L1) and red (L3) LED's off.
- I. The solid state relay (R6) OFF.
- J. Convection fan motor (MTR1) energizes.

Cold Water Condensate

NOTE: TC1 does not monitor water as it exits the oven, rather it monitors water as it exits the oven cavity. Inside the bent drain tube assembly, it mixes cooling water in as necessary to achieve proper exit temperature of the water.

- 1. Water inside drain assembly is monitored by Main I/O board using drain water sensor TC1.
- 2. When water temperature inside drain assembly is above (P25 parameter) 160°F (new bent tube drain), or 140°F (old NPT pipe drain), cold water condensate valve (SOL1) is energized. This allows cold water to mix in to achieve the proper exit temperature of drain water.
- 3. When water temperature inside drain assembly is below (P26 parameter) 155°F (new bent tube drain), or 130°F (old NPT pipe drain), cold water condensate valve (SOL1) is de-energized.
- 4. Every two hours, cold water condensate valve (SOL1) is energized for 6 seconds to ensure p-trap remains full of water. This prevents cold air being sucked into drain and into cooking cavity.

NOTE: Parameter P25 and P26 are set based on drain type, not firmware revision.

Rapid Cool Feature

- 1. Temperature setpoint is turned down by operator, so RDT1 temperature is now 70°F higher than the temperature setpoint.

A. Main board checks status of SW1 and SW2 (Cavity Vent switches).

- 1) If switches indicate vent is closed, the cavity vent intake motor is energized.
- 2) When switches indicate vent is fully opened, the cavity vent intake motor is de-energized.

B. Humidity (high flow) water valve (SOL3) is energized.

C. Humidity (low flow) water valve (SOL2) is energized.

2. When RDT1 temperature drops to within 70°F of the temperature setting:

A. Humidity (high flow) water valve (SOL3) is de-energized.

B. Humidity (low flow) water valve (SOL2) is de-energized.

Motor Control Board

- 1. Main I/O board sends signals through the ribbon cable to motor board.
- 2. Amber colored LED turns on to indicate that a drive signal or a brake signal.
- 3. Green colored LED indicates direction of the motor and toggles its state from on to off (or off to on) every 2 minutes during a cooking cycle.

NOTE: State of the onboard reversing relay changes every two minutes (indicated by LED). This reverses phases of the motor to reverse motor direction.

- 4. Red LED indicates presence of current in convection fan motor, and signals the main I/O board through ribbon cable.
- 5. Solid State Relay (R6) energizes, at a delayed on time (as programmed in P12 CONFIGURATION MODE (1972) ELECTRIC) every 60 hertz cycle to control motor speed (fire angle control).
- 6. Convection fan motor (MTR1) energizes (at low, medium or high speed setting).

CIRCUIT BOARD LAYOUTS

MAIN BOARD CONNECTIONS

Meter readings for different settings on unit.

NOTE: Temperature knob presets to best set humidity. However, humidity can be adjusted.

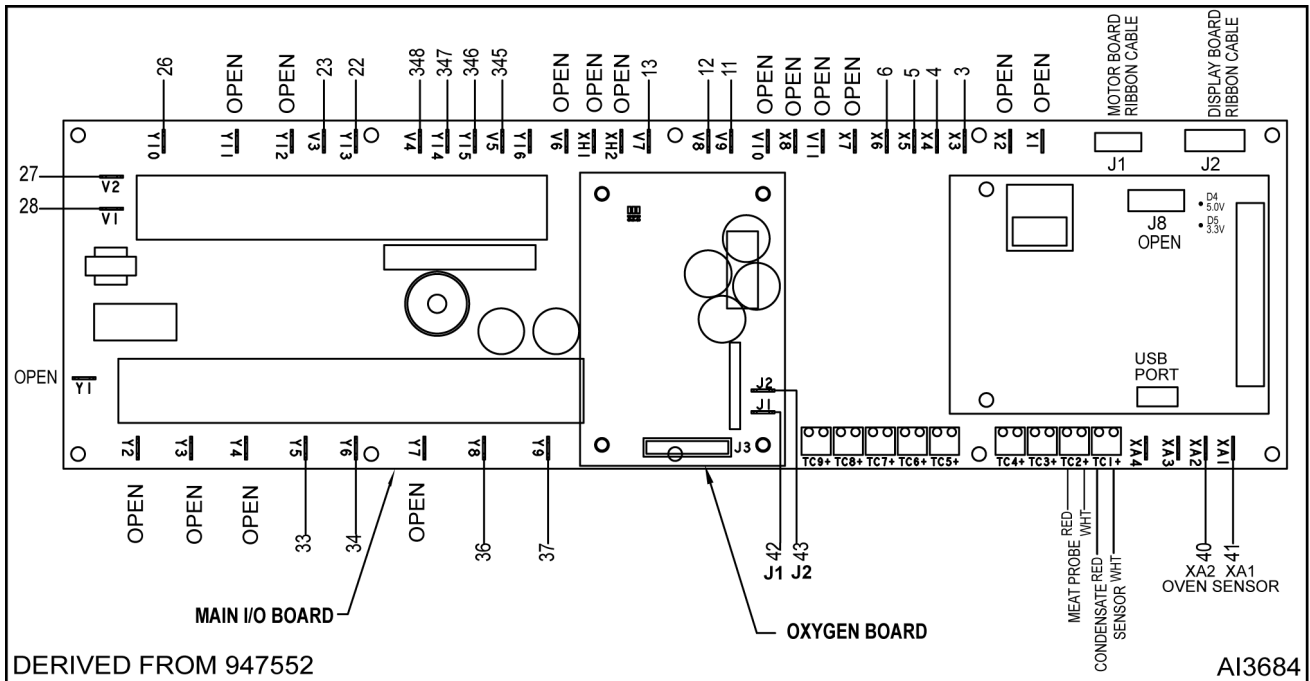

MAIN CONTROL BOARD CONNECTIONS

Oxygen Board Connections (Function)		
Designation	Wire number connected	Function
J1	Wire 42	12 VAC (OXY) input
J2	Wire 43	12 VAC (OXY) (COM)
J3	Cable	Wire harness connected to Oxygen sensor (SW5)

Oxygen Board voltage readings			
Designation	Reference Point	ON/OFF Switch (OFF)	ON/OFF Switch (ON)
J1	J2	0 V	12 VAC

MAIN I/O BOARD CONNECTIONS (FUNCTION)		
Designation	Wire number connected	Function
J1	Ribbon Cable	Ribbon cable connection for Motor Board.
J2	Ribbon Cable	Ribbon cable connection for Display Board.
TC1+	White wire	Condensate tempering probe input.
TC1-	Red wire	Condensate tempering probe input.
TC2+	White wire	External Meat probe thermocouple.
TC2-	Red wire	External Meat probe thermocouple.
V1	Wire 28	230 VAC input (From On / Off switch).
V2	Wire 27	230 VAC (COM) input.
V3	Wire 23	12 VAC (Lite) input.
V4	Wire 348	230 VAC (COM) input.
V5	Wire 345	230 VAC input.
V6	Wire 16	24 VAC (IM) input.
V7	Wire 13	Chassis Ground input.
V8	Wire 12	24 VAC (COM) input.
V9	Wire 11	24 VAC input.
V11	Wire 8	24 VAC (IM) (COM) input.
XA1	Wire 41	Oven Sensor RDT1 input.
XA2	Wire 40	Oven Sensor RDT1 input.
X3	Wire 3	Cavity Vent Switch (SW1) input.
X4	Wire 4	Cavity Vent Switch (SW2) input.
X5	Wire 5	Hi Limit Sense Switch input.
X6	Wire 6	Door Switch input.
Y5	Wire 33	Output for Humidity fill valve (high) relay.
Y6	Wire 34	Output for Cooling Fans (CF1, CF2 and CF3) relay.
Y8	Wire 36	Output for Humidity fill valve (low) relay.
Y9	Wire 37	Output for Condensate tempering valve relay.
Y10	Wire 26	Output for Cavity Vent Intake Motor relay .
Y13	Wire 22	Output for Cavity Lamp relay.
Y14	Wire 347	Output for low Heat relay.
Y15	wire 346	Output for high Heat relay.

Main I/O Board Connection Points (Output Voltage Readings)					
Designation	Reference Point	ON/OFF Switch (OFF)	ON/OFF Switch (ON)		
			Temperature Knob Set to "----" (0°F)	Temperature Knob > 80°F	Service Tests Mode
Y5	V2	0 VAC	0 VAC	230 VAC as needed. Controlled by temp or humidity settings.	230 VAC
Y6	V2	0 VAC	230 VAC	230 VAC	230 VAC
Y8	V2	0 VAC	0 VAC	230 VAC as needed when temp is within 50° of setpoint. Controlled by oxygen sensor and humidity setting.	230 VAC
Y9	V2	0 VAC	230 VAC for 6 seconds when on/off switch turned on.	230 Vac for 6 seconds every 2 hours to fill p-trap; and if Drain Water Sensor Input calls for cold water.	230 VAC
Y10	V2	0 VAC	230 VAC for 15 seconds when on/off switch turned on to close vent.	230 VAC for 15 seconds controlled by oxygen sensor & humidity setting.	230 VAC for 15 seconds.
Y13	TB4-9	0 VAC	12 VAC when door is open.	12 VAC when door is open.	12 VAC when door is open.
Y14	V4	0 VAC	0 VAC	230 VAC when low heat called for.	230 VAC
Y15	V4	0 VAC	0 VAC	230 VAC when high heat called for.	230 VAC

MOTOR BOARD

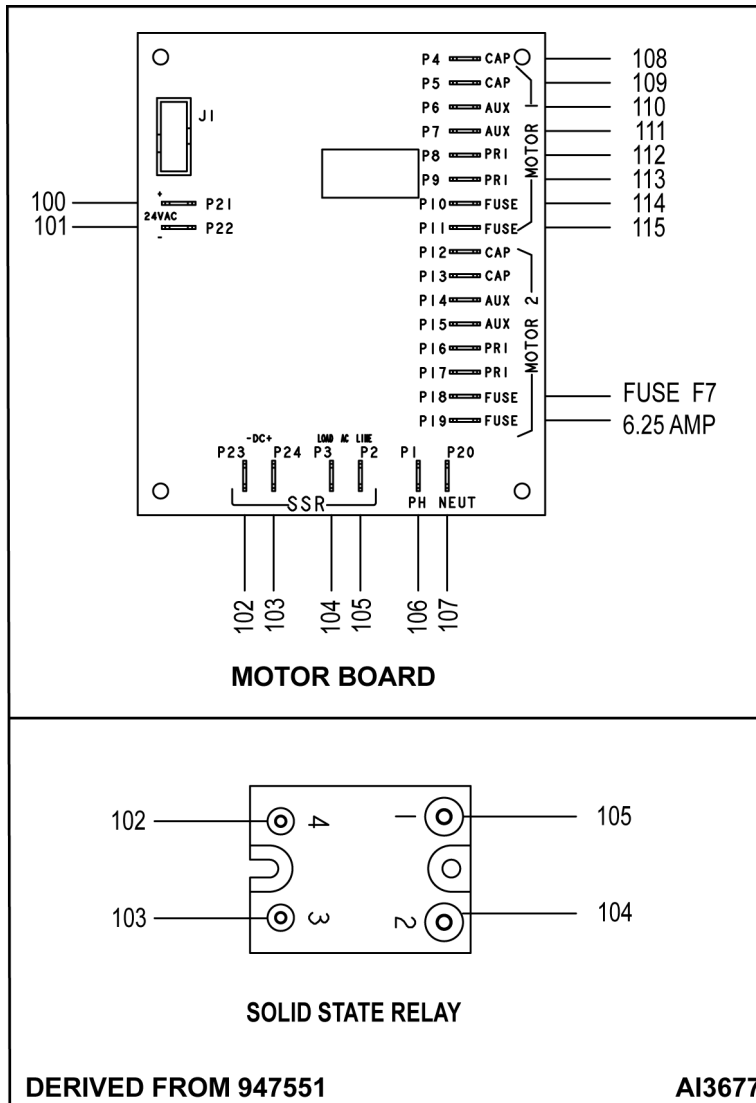

Fig. 126

WIRING DIAGRAMS

TERMINAL BLOCKS

TERMINAL BLOCK
TB1

	CHASIS	A	B	TB	C	D
SEE NOTE 1				13		
TRANSFORMER PRIMARY	480	140		480V		342
	240	141		240V		(342)
	208	142		208V		(342)
	120	143		120V		
	COM	144		8		343
TRANSFORMER SECONDARY	230-PH		345	7		
	230-PH	145	57	6	336	124
	230-N	146	125	5	348	80
	230-N	139	131	4	72	69
	230-N	68	67	3	27	60
	230-N			2		339
	FANS	34	79	1	138	130

WIRE 342 CONNECTED
FOR CUSTOMER VOLTAGE
AT FACTORY

TERMINAL BLOCK
TB3

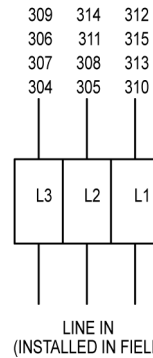

TERMINAL BLOCK
TB4

		A	B	TB	C	D	FUSE	SERVICES
TRANSFORMER SECONDARY	12V	FUSED (4A)	147	20		87	FUSE LINK IN HEAT SHRINK F1	OXYGEN BOARD
	12V	FUSED (4A)	149	18		86	FUSE LINK IN HEAT SHRINK F2	CAVITY LIGHTS
	24V	FUSED (4A)	151	16		85	FUSE LINK IN HEAT SHRINK F3	VENT & DOOR SW. HI LIMIT SENSE MOTOR BD.
	24V IM		153	14				
				13				
	12V OXY	+12	87		12		126	
		-12	148		11		127	
	12V LITE	+12	86		10		23	
		-12	150		9		74	
	24V FUSED	+24	53		8	11	100	
			85	48	7	49	50	
		-24			6			
			152		5	12	101	
					4			
					3			
				2				
	-24V IM	154		1				

DERIVED FROM 947552

AI3680

Fig. 127

T1 TRANSFORMER

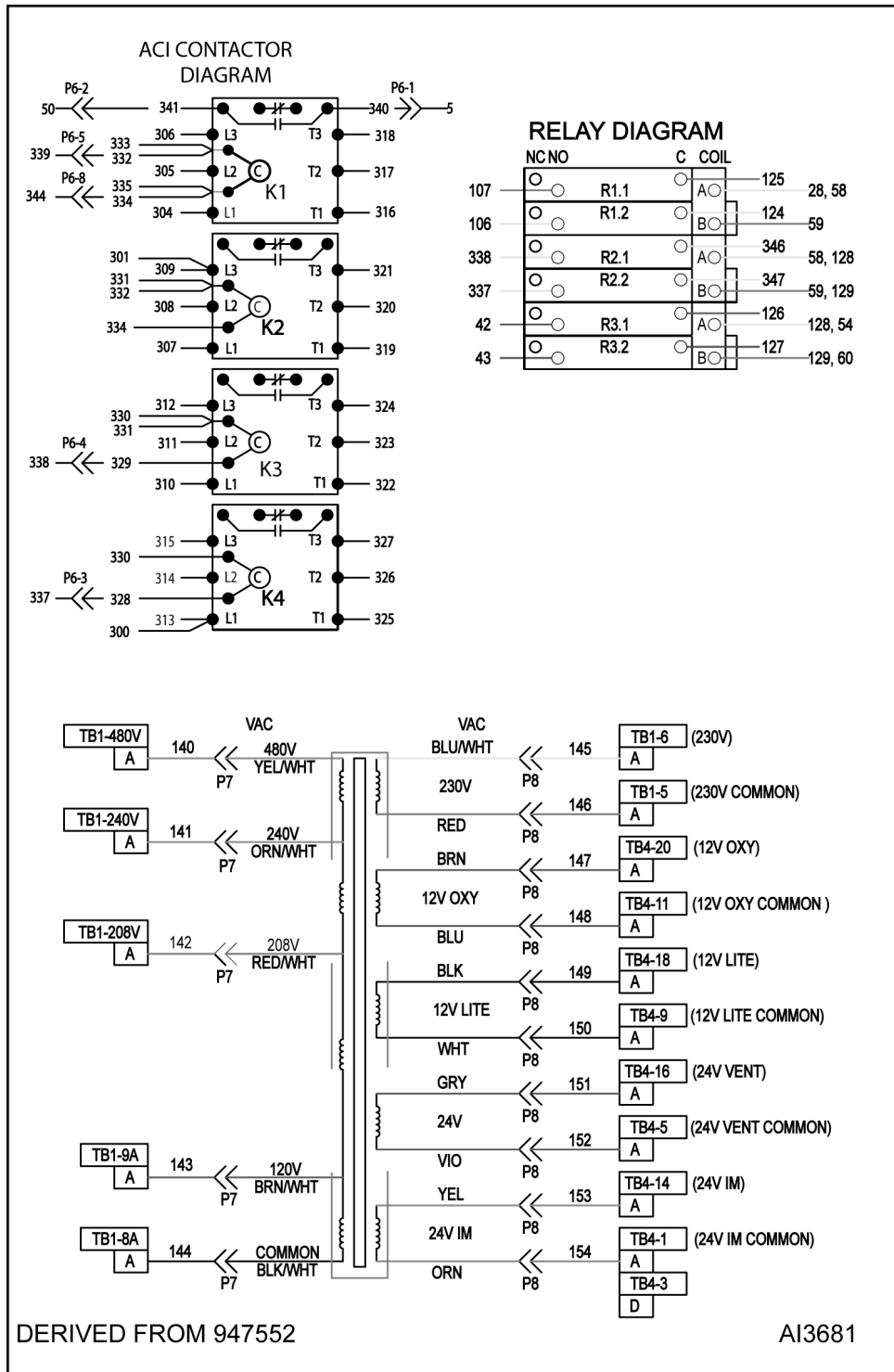

Fig. 128

HEATING ELEMENTS

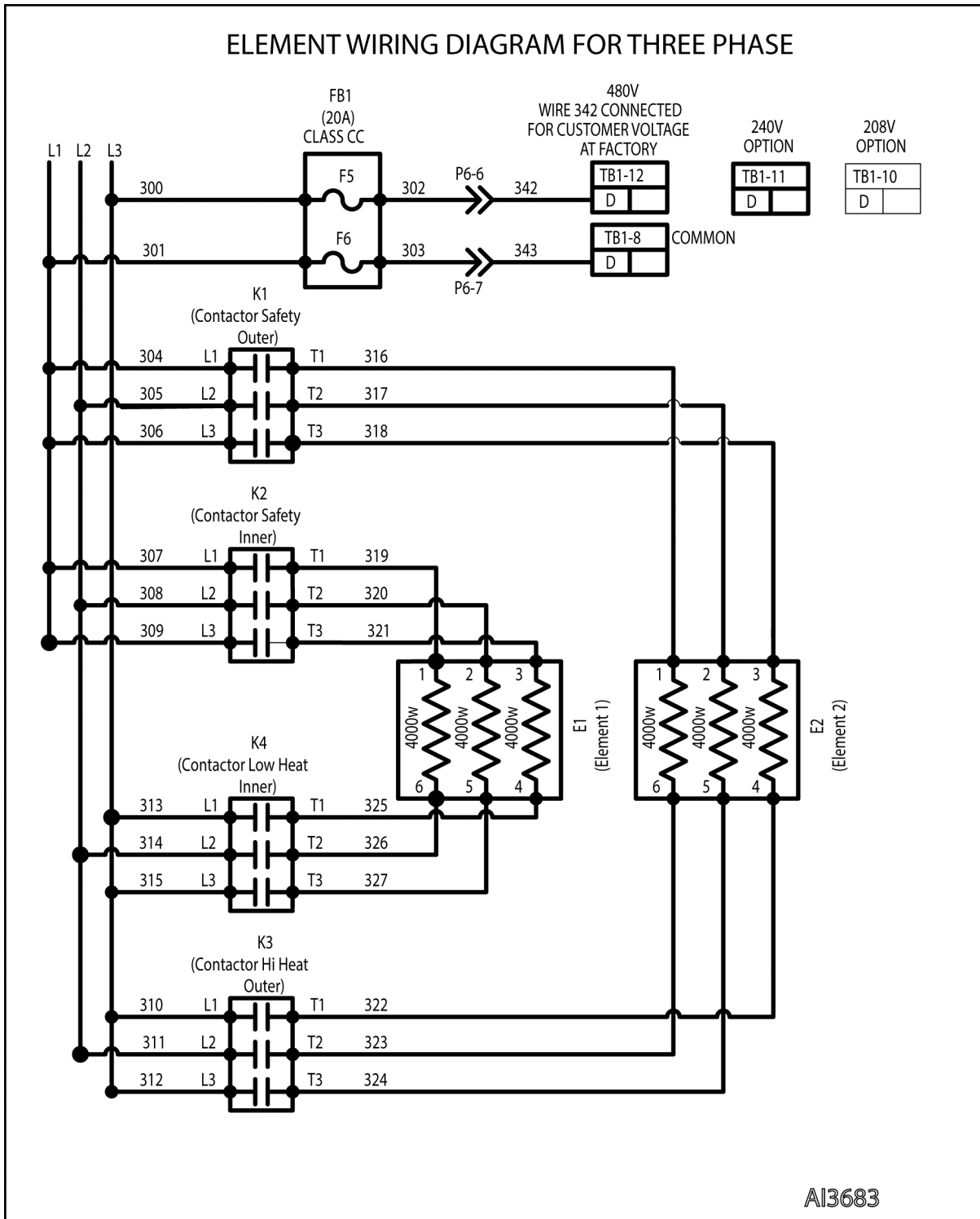

Fig. 129

NOTE: Heating Elements derated to 3000W at 208 V.

MAIN BOARD

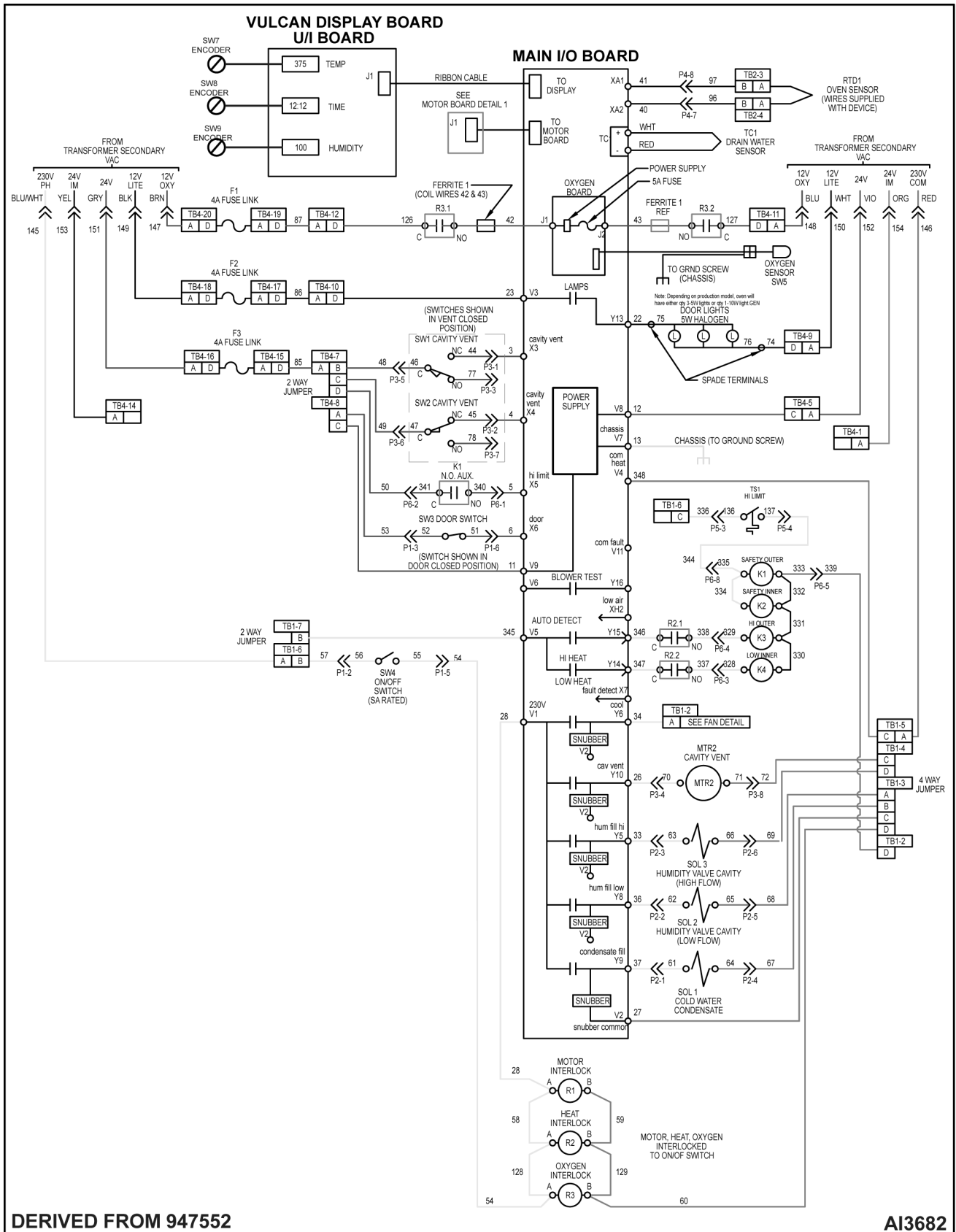

Fig. 130

MOTOR BOARD

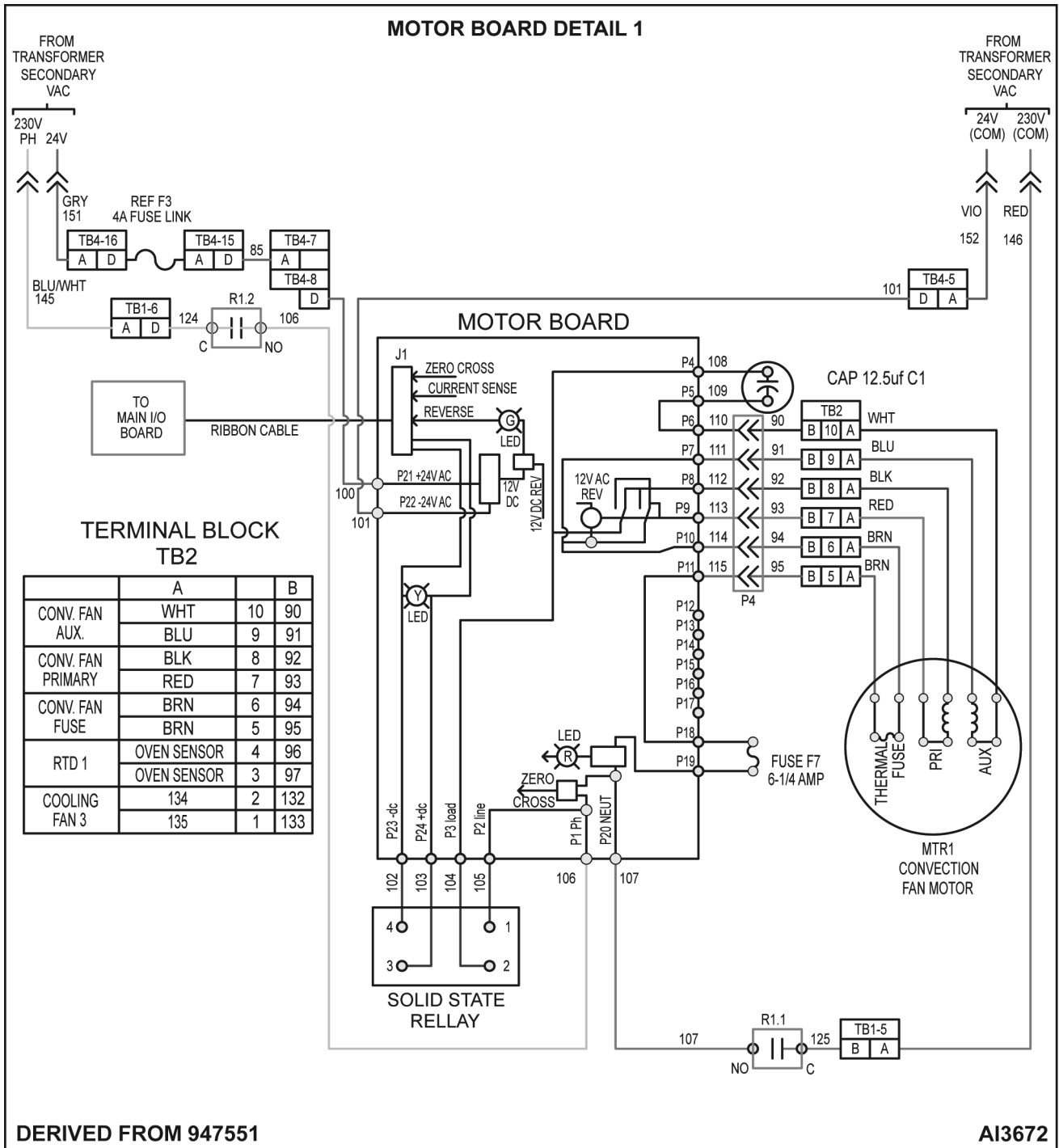

Fig. 131

COOLING FANS

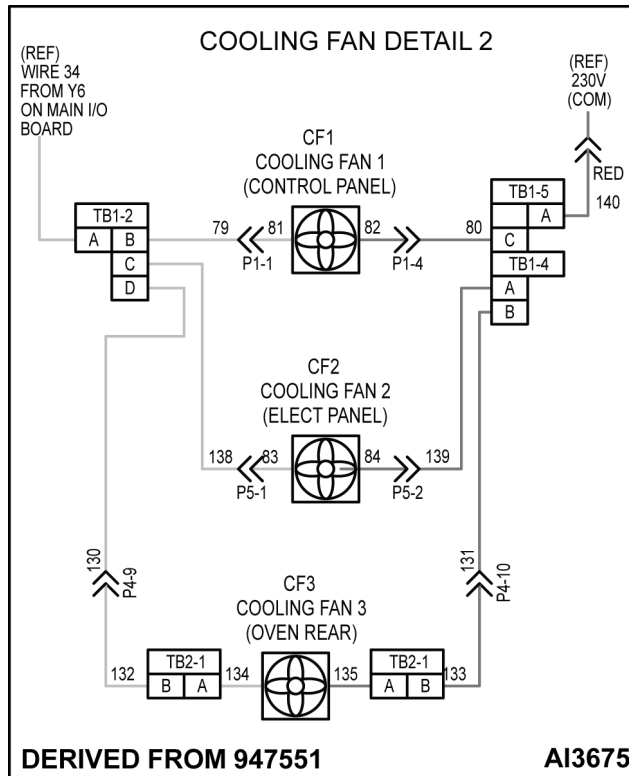
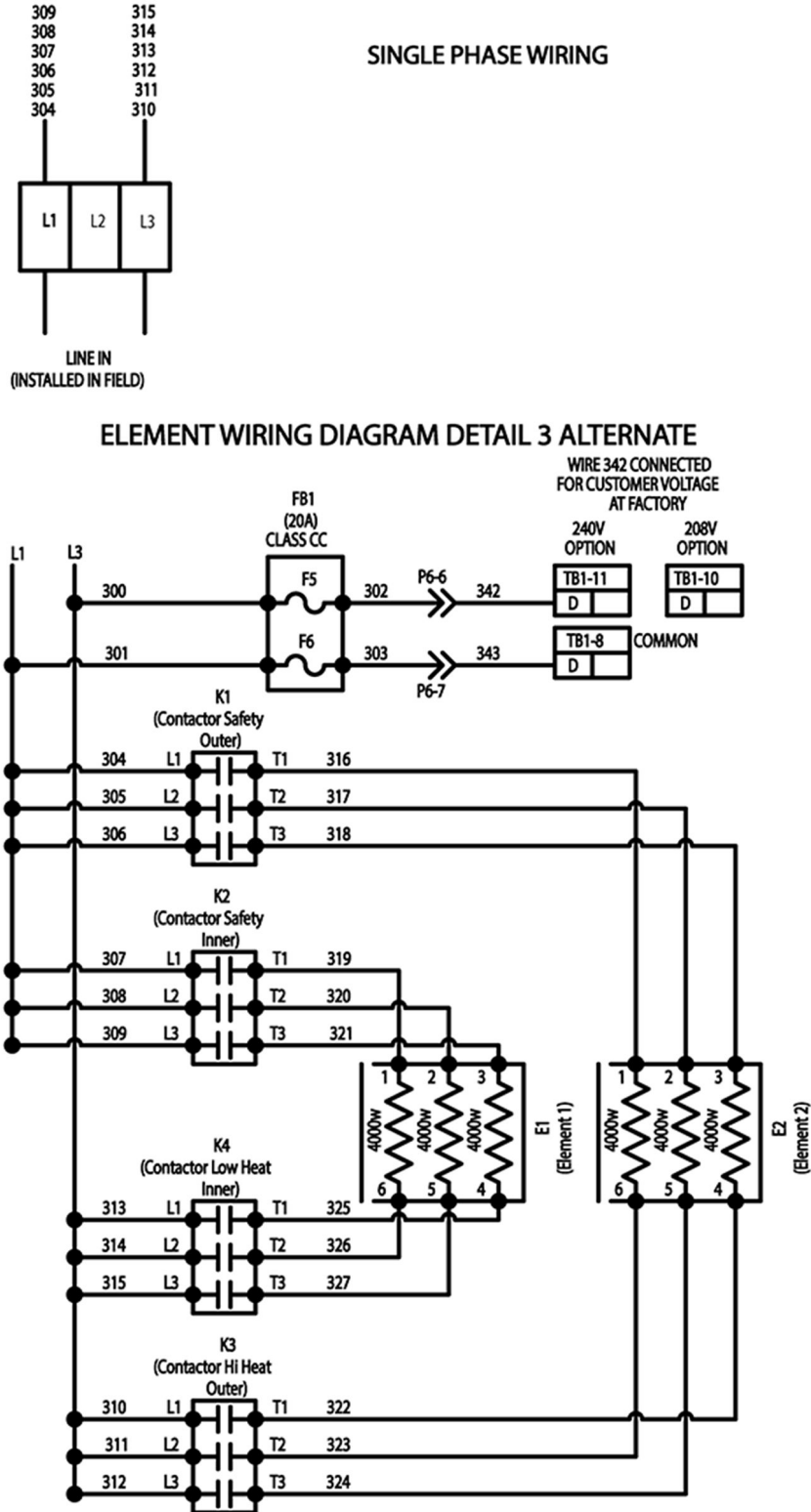

Fig. 132

WIRING CHANGES FOR SINGLE PHASE

NOTE: 7 in. lbs. torque required on TB3.



AI3723

Fig. 133

DIAGNOSTICS / TROUBLESHOOTING

SERVICE MODE (1963)

Log into Service Mode 1963

1. Turn unit on.
 - NOTE:** Oven must have no temperature set to enter Service Mode.
2. Turn Timer knob counterclockwise until Timer display shows "SEt".
3. Turn Humidity knob counterclockwise until Humidity display shows "PAS".
 - A. Timer display will show "2000".
4. Turn Timer display counterclockwise to 1963.
 - A. Timer display will flash "1963".
 - B. Timer and Humidity display will flash twice.
 - C. Humidity display changes from "PAs" to "tst" when logging into Service Mode.

NOTE: Humidity knob used to change setting.

NOTE: Tests function with door open or closed.

NOTE: For some tests (Y5 - Y13), Time display toggles between test number and data reading such as current or temperature.

NOTE: View TC1 in Y9 test. View TC2 in P21 Calibration in CONFIGURATION MODE (1972) ELECTRIC.

Temp. Display ("---")	Description	Timer Display ("---")	Humidity Display ("---")
P0	Current firmware code revision (Month, day, year). Time and Humidity show example.	0424 (Month: 04, Date:24)	17 (Year: 2017)
S5	High limit thermostat status.	HI / LO	HI / CLS (Switch closed) LO / oPn (Switch open)
S6	State of Door Switch. Open / Close door to test switch.	door	HI / CLS (Switch closed) Lo / oPn (Switch open)
S10	State of O/I Switch. Toggle front panel switch to test.	AC	on / off
S11	Electric vs Gas. Auto detects if oven is gas or electric.	tyPE	HI / ELE

Temp. Display ("---")	Description	Timer Display ("--:--")	Humidity Display ("---")
rd1	Oven Cavity Temperature.	(current oven temp) E2 indicates reading out of range. 556F indicates open circuit. <40F indicates short circuit.	oVn
o 1	Oxygen sensor power. Verifies 12VAC is supplied to Oxygen Sensor Board.	o2Pr	on/Err on - Oxygen board is powered. Err - Oxygen board is not powered.
o2	Oxygen sensor board revision number.	orREV	example: 012 (If no revision number seen - power off / on to recognize revision date). NOTE: Revision 12 is backward compatible to ovens serial number 541083068 and before and is a required upgrade when changing a sensor.

Temp. Display ("---")	Description	Timer Display ("--:--")	Humidity Display ("---")
o 3	<p>Oxygen Board /Oxygen Sensor status.</p> <p>NOTE: Reported as a pair.</p>	02bd	<p>00 / oFF</p> <ul style="list-style-type: none"> Oxygen board not transmitting a status. Check connections. <p>01 / HT</p> <ul style="list-style-type: none"> Oxygen board is heating the oxygen sensor. Wait 3 minutes for warming after power is applied. <p>02 / rdY</p> <ul style="list-style-type: none"> Oxygen board is ready and transmitting humidity data from sensor. <p>03 / Cal</p> <ul style="list-style-type: none"> Oxygen board can't calibrate itself. Damaged Oxygen board. <p>04 / Cur (Current error)</p> <ul style="list-style-type: none"> Oxygen board can't sense current in oxygen sensor heater. Check for disconnected sensor.
o 4	<p>Oxygen sensor data.</p> <p>Shown in % of Absolute Humidity. This value will not match the % Relative Humidity value shown on User interface at oven cavity temperatures less than 212°F.</p> <p>Same value as P33 in <u>CONFIGURATION MODE (1972) ELECTRIC</u>.</p> <p>NOTE: Combine the numbers in the two displays to get the complete percentage.</p>	<p>051</p> <p>Combine the two numbers to get 51.2 %.</p>	.2
o5	Reports duty cycle of the oxygen sensor heater regulation.	duty	Example: 33

Temp. Display ("---")	Description	Timer Display ("--:--")	Humidity Display ("---")
o6	Reports ramp input given to oxygen board.	rAanP/0005	
o7	Reports condensation time phase input given to oxygen board.	PHAS/0001	
F1	Convection fan Test. 1. Checks fan speeds 3 through 7. Visually check for change in fan speed.	SPd / Ion	oFF, 3, 4, 5, 6, 7
	2. Checks current sensing of motor. Visually check for display to change from loFF to Ion in Timer display.	SPd / Ion SPd / loFF	
	3. Checks breaking of motor. Visually check for convection fan breaking to a stop and not coasting to a stop.	SPd / loFF	
F3	Convection Fan Reverse Test. Turn humidity knob to initiate test. Note direction of fan. For example, clockwise. Turn humidity knob to reverse motor. Note direction of fan has changed. For example, counterclockwise. NOTE: Turning humidity knob too quickly during breaking sequence, will cause oven to beep.	rEV Ion / loFF	HI / Lo
Y5	Humidity High Flow Water Valve. When turned on, water will flow out of water atomizer. NOTE: Valve flow rate = 15 liters / hour (.25 liter / min).	H2HI When on, Timer display toggles between H2H1 and a value to indicate solenoid is energized. Expected value = 6 ± 1 NOTE: Wait 10 seconds for proper value reading in timer display. NOTE: When Timer displays "=Err", indicates that the valve is not drawing the proper current.	on / oFF

Temp. Display ("---")	Description	Timer Display ("--:--")	Humidity Display ("---")
Y6	<p>Cooling fans.</p> <p>Fan 1 (control panel), fan 2 (display panel), fan 3 (oven rear).</p>	<p>CFAn / (Current Sense value)</p> <p>When on, Timer display toggles between CFan and a value to indicate fans are energized.</p> <p>Expected value = approximately 99 for 3 fans, 66 for 2 fans.</p> <p>NOTE: When Timer displays "=Err", indicates that the fans are not drawing the proper current.</p>	<p>on / oFF</p>
Y8	<p>Humidity Low Flow Water Valve.</p> <p>When turned on, water will flow out of water atomizer.</p> <p>NOTE: Valve flow rate = 15 liters / hour (.25 liter / min).</p>	<p>H2Lo</p> <p>When on, Timer display toggles between H2Lo and a value to indicate solenoid is energized.</p> <p>Expected value = 6 ± 1</p> <p>NOTE: Wait 10 seconds for proper value reading in timer display.</p> <p>NOTE: When Timer displays "=Err", indicates that the valve is not drawing the proper current.</p>	<p>on / oFF</p>
Y9	<p>Water drain Condensate Valve.</p> <p>When turned on, water will flow out drain.</p> <p>NOTE: Valve flow rate = 300 liters / hour (5 liters / min).</p>	<p>H2dr / Drain Temp</p> <p>When on, Timer display toggles between three things. H2dr which is the name of the test, a value to indicate solenoid is energized (settles at a value of 6 ± 1) and the drain tempering probe's (TC1) temperature.</p> <p>NOTE: When Timer displays "=Err", indicates that the valve is not drawing the proper current.</p>	<p>on / oFF</p>

Temp. Display ("---")	Description	Timer Display ("--:--")	Humidity Display ("---")
Y10	<p>Cavity Vent Intake. Current sense and Vent operation test.</p> <ol style="list-style-type: none"> 1. Checks state of vent switches. 2. Checks rotation of vent motor, quarter turn at a time. 3. Times rotation of quarter turn, to verify vent switches seat properly on shaft. 4. Checks for current feedback to verify motor is energized. <p>NOTE: Properly check cavity vent intake by turning humidity knob between oPn and CLS a minimum of 4 times to get full rotation.</p>	<p>VEnt / CLSd SPIn / =5</p> <p>Display toggles. SPIn indicates switches are in spinning state. "=5" is an approximate number which indicates motor is energized properly.</p> <p>When complete: VEnt / oPEn</p> <p>NOTE: "Err/=5", switches are in an error state. Refer to: <u>CAVITY VENT SWITCH TEST AND ADJUSTMENT.</u></p> <p>NOTE: When timer display "=Err" indicates that the vent motor is not drawing the proper current.</p>	<p>Humidity display shows CLS. CLS, turn humidity knob to initiate test.</p> <p>Display counts up to 15 seconds, if operating properly.</p> <p>When complete: Humidity knob will read oPn.</p> <p>NOTE: Counts past 15 indicate switches have not seated properly, "Err" displays after 75 seconds. Test continues to run.</p>
Y13	Oven cavity door light.	<p>LiTE</p> <p>when on, Timer display toggles between LiTE and a value to indicate lights are energized.</p> <p>Expected values:</p> <p>75 for 3 lights 50 for 2 lights 25 for 1 light 0 for no lights on</p>	on / oFF
Y14	Low Heat Inner Elements.	<p>Lo Ht</p> <p>Display toggles between Lo Ht and the temperature reading from RTD1 temperature probe.</p>	on / oFF
Y15	High Heat Outer Elements.	<p>Hi Ht</p> <p>Display toggles between Hi Ht and the temperature reading from RTD1 temperature probe.</p>	on / oFF
Pb	Reports the press of the push button encoder (ABCx-xxxP devices only).	<p>--- (Not Pressed) PUSH (Timer Pressed)</p>	<p>--- (Not Pressed) PUSH (Hum Pressed)</p>
d1	<p>Display</p> <p>Test - assure led light segments operate.</p>	<p>Temperature, Timer, Humidity displays sequence thru dots and digits 0 - 9. (Example: ..., 000, 111, etc.)</p>	oFF / on

Temp. Display ("---")	Description	Timer Display ("--:--")	Humidity Display ("---")
HUn gAL	Humidity Water Counter. NOTE: Same value as P19 in <u>CONFIGURATION MODE (1972) ELECTRIC.</u>	Example: 0009	Example: 999 Example: Total gallons: 9,999.
Cnd gAL	Condensate Tempering Water Counter. NOTE: Same value as P20 in <u>CONFIGURATION MODE (1972) ELECTRIC.</u>	Example: 0009	Example: 999 Example: Total gallons: 9,999.
HRS	Cooking Hours. NOTE: Same value as P18 in <u>CONFIGURATION MODE (1972) ELECTRIC.</u> (Hour counter does not increment in idle mode.)	Example: 0009	Example: 999 Example: Total hours: 9,999.
LOg	(Refer to <u>ERROR CODES.</u>)		
E0 through E21	(Refer to <u>ERROR CODES.</u>)		

Logging out of Service Mode 1963

1. Turn Temperature knob counterclockwise until "---" displayed.

ERROR CODES

In cook mode, the oven always checks for errors. The oven does not check for errors in idle mode, (all displays show ----). All errors are stored into a log in SERVICE MODE (1963). Some errors are considered critical, that the oven cannot operate and if detected, everything is shut down, and error number is displayed, and oven beeps continually.

NOTE: E6 error is the exception to the rule and is the only error logged during idle time.

To turn off continuous beep, toggle on/off switch. If condition still exists error will reappear immediately. If error beep turns back on, turn Timer knob counterclockwise, back to idle mode "----".

NOTICE

ERRORS 0 - 2 below are "critical" errors. Oven will not function in this condition. All processes are stopped and oven is shut down.

Some errors are considered non-critical, where something requires service, but oven can still cook. Some of these errors are displayed in operator interface, so customer knows to call for service. Other non-critical errors are logged as a diagnostics tool for service.

When an error code is logged, the hour that the error occurred is recorded. The hours in the log are cooking hours. Cooking hours are the number of hours the oven has been in use. Cooking hours do not increase during idle time (all displays show ----). So if a school uses an oven 6 hours a day, 5 days a week, the cooking hours will increase 30 hours a week.

Log into Service Mode 1963

1. Turn unit on.
2. Turn Timer knob counterclockwise until Timer display shows "SEt".
3. Turn Humidity knob counterclockwise until Humidity display shows "PAS".
 - A. Timer display will show "2000".
4. Turn Timer display counterclockwise to 1963.
 - A. Timer display will flash "1963".
 - B. Timer and Humidity display will flash twice.
 - C. Humidity display changes from "PAs" to "tst" when logging into Service Mode.
5. Turn Temperature knob clockwise through all tests in service mode, until "HRS" is displayed in the Temperature display.

This displays the current number of cooking hours in the Timer and Humidity displays. Make a note of the hour listed. This is important so that you can tell how long it has been since the error has occurred.

To read the current number of hours

- A. With HRS displayed in the temperature display.
 - B. 0009 in the Timer display.
 - C. 999 in the humidity display.
 - D. The oven would have 9,999 cooking hours.
6. Turn Timer knob clockwise one more click then "LOg" is displayed in the Temperature display.

There are two ways error codes are stored, sequential log and error bucket.

Sequential log: A quick timed ordered list on errors recorded.

Error buckets: Each bucket, E0...E21, displays an individual error and every hour that the error occurred.

How to read sequential Log

When Log is shown in Temperature display, sequential error log is being displayed. The last stored error is shown in the Timer display. Then the Timer display, in conjunction with the Humidity display toggles the hour count when error occurred.

Sequential Log

1. With Log displayed in the temperature display.
2. Timer Display toggles between E1 and 0009.
3. Humidity display flashing 999
4. Means that an E1 error occurred at cooking hour 9,999.

This is a sequential log. To view the next error recorded, turn Timer knob clockwise. If no more errors have been recorded, Timer displays "ErrS" and Humidity displays "End". If multiple errors have been recorded, "--]" will be displayed in Temperature display when Timer knob is turned. The next error in the sequential log is shown in the Timer display. Then the Timer display in conjunction with the humidity display toggles between error code and hour in which the error occurred.

NOTE: As the sequential log stores multiple error logs, only view the last few error codes to know what errors have occurred to pRev.ent oven from working properly.

How to Read Error Buckets

To view bucket list, turn Temperature knob clockwise to start error buckets, starting at E0. If no errors have been recorded for E0, then Temperature displays "E0 (error code)", Timer displays "ErrS", Humidity displays "End". If no errors are displayed in error bucket, turn Temperature knob clockwise to next error.

If errors are recorded in error bucket, Temperature displays "E0 (error code)", Timer and humidity displays oven hour count the error last occurred. If multiple errors have been recorded, "--]" will be displayed in Temperature display. When Timer knob is turned clockwise, the oven will display each recorded event and associated hour count. The next hour count is shown in Timer and Humidity displays. To view multiple hours recorded, continue turning Timer knob clockwise. Timer knob will show "ErrS" and Humidity display will show "End" when all recorded hours have been displayed.

NOTE: Multiple errors can be recorded during the same hour, turning the Humidity knob clockwise will skip hour by hour, not displaying each individual recorded event.

- E0** High Limit Error (Critical Error): Oven overheats, tripping high limit thermostat, and removes voltage from Contactors K1 and K2.
- E1** Convection Fan Motor Error (Critical Error): Motor Board does not sense current to motor. Possible causes: 1) Convection fan has overheated and fan's thermal fuse has tripped, or 2) motor board's 6-1/4 fuse amp has been blown.
- E2** RTD Probe Error (Critical Error): Probe RTD readings are out of range indicating main board problem.
- E3** (Future Use.)
- E4** Controls Compartment Ambient Error: Operating temperature of controls has exceeded recommenced temperature limits for more than 15 minutes.
- E5** Drain Tempering Probe Error: Drain tempering probe readings are out of the range of 32°F to 250°F range.

- E6** Convection Fan Current Error: Control board reads current to convection fan motor, when convection fan should be off.
Error E6 is the only error that can be logged during idle mode.
- E7** Auto Electric or Gas Detection Error: Control board cannot auto detect type of unit or state of auto detect pin has changed.
- E14** Logs an E14 error if USB is not functioning on main board. (Requires IAP 6.21.)
- E15** Vent Error: Either vent motor has a problem and cannot rotate, or the vent switches are out of adjustment and cannot tell vent motor when to stop its rotation at the open or closed position. This means the system cannot humidify efficiently. Although switches should seat into position within 15 seconds for a quarter turn, error will not be logged until vent motor runs 75 seconds without completing.
- E16** For 4-24-17 firmware Rev.isions and above: E16 inactive, replaced with E22 – E28.
For 8-11-14, 2-25-14 firmware Rev.isions: In cook mode, where oxygen sensor/oxygen sensor board has fallen out of its **ready** status.
1. Stuck in warming.
 2. Communication error.
 3. Internal oxygen board heating or calibration error.
- E17** (Future Use.)
- E18** In cook mode, where oxygen sensor board has lost 12V supply.
- E19** (Future Use.)
- E20** **Cooling Fan Dropout:** Current not sensed in one or more of the cooling fans. Check cooling fans to ensure fans are functioning properly.
- E21** Logs an error when part of the motor speed control zero cross circuit on either the motor board or main board is inoperable. (Logs error when 60 seconds has passed without seeing a 60Hz zero cross signal.)
- E22** Log event created when condition persists for more than 60 seconds for "no COMM". Communication dropout between oxygen & main boards. Indicates board error (if together with no power, an E18 is logged instead).
- E23** Log event created when condition persists for more than 60 seconds for "bad COMM". Communication unrecognized status received from oxy board. Indicates board error.
- E24** Log event created when condition persists for more than 60 seconds for "bad reading", "stuck" at 100% absolute humidity, for more than 60 seconds. Indicates damaged oxygen sensor.
- E25** Log event created when condition persists for more than 60 seconds for "under heating".
- Undershoot of the sensor's heater regulation. Status 01 is returned for more than 60 seconds after first o.k. status (after warm-up complete) indicating intermittent electrical noise interference. (Rev. 12 amber LED, Rev. 11 red LED, comes back on for more than 60 seconds after warm-up complete.)
 - Stuck in warming. Status 01 is returned for more than 3 minutes before the first o.k. status when the board is reset or following a COMM error. (Rev. 12 amber LED, Rev. 11 red LED, never turns off after power up.)
- E26** Log event created when condition persists for more than 60 seconds for "damaged oxygen board". Status 03 returned from the oxy board indicating on board IC's cannot calibrate themselves.

- E27** Log event created when condition persists for more than 60 seconds for "cannot heat sensor". Status 04 returned from the oxy board indicating no heater current and possibly an open sensor, unplugged sensor or intermittent connection.
- E28** Log event created when condition persists for more than 60 seconds for "overheating".
- Overshoot of the sensor's heater regulation. Status 05 returned from the oxy board for more than 60 seconds indicating intermittent electrical noise interference. (Rev. 12 oxygen board's red LED comes on for more than 60 seconds, after warm-up complete.)
- NOTE:** E28 error requires Rev. 12 oxygen sensor board. When using Rev. 11 oxygen sensor board, the overheating condition is logged as E25.
- E29** Logs E29 error when RTD reads abnormally low <40F indicating a damaged sensor.

Logging out of Service Mode 1963

1. Turn Temperature knob counterclockwise until "---" displayed.

LED display showing all "8's"

- This is a possible malfunction with ribbon cable or main board.



Fig. 134

Error Download to USB Flash Drive

NOTE: It may be necessary to down load the error log to USB flash drive, and send it to warranty administrator for further Review.

1. Enter SERVICE MODE (1963).

NOTE: Must be in service test mode. Inserting the flash drive during cook, configuration or idle mode will represent a different function.

2. Insert USB flash drive into oven USB port. Display will show “USB dLog n_y”.

NOTE: If something other than Usb Flsh n_y is displayed, then refer to USB ERROR MESSAGES.

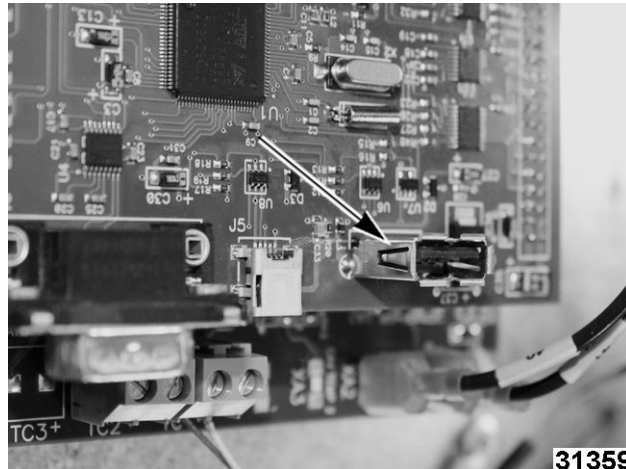

Fig. 135

3. Select y (turn the humidity knob to the right) to initiate the log download. Selecting n will cancel back to test mode.
4. If y is selected, the Hum display will briefly show Yes, then will begin showing a percentage complete from 0 – 100 as the log files are downloaded.
 - The download may take several seconds, depending on how many errors are in the log. When download is complete, Hum display will briefly show "don", then the oven returns to test mode.
 - USB drive will now contain a root folder called “ABCCombi”, with a subfolder named with the version number for the software on the oven (e.g. “081114” or “042417”). Inside this subfolder will be the log files. These include:
 - Log_All.txt – This is a simply formatted text file comprising all of the errors in the log (from most to least recent). The oven hour and minute counter and water counters at the time downloaded are also included at the top. A brief header is inserted before error entries for a new/different hour.
 - Log_En.txt (for each error E0 - En) – These are formatted the same as Log_All.txt, but include only the error type specified by En (analogous to the E0 - En tests within test mode described above).
 - Log_JSON.txt – This file contains the error log contents in a simple JSON text format. Some miscellaneous additional data (oven hour and minute counter and water counters) are also included.

OVEN TROUBLESHOOTING

**⚠ WARNING**

Certain procedures in this section require electrical test or measurements while power is applied to the machine. Exercise extreme caution at all times and follow Arc Flash procedures. If test points are not easily accessible, disconnect power and follow Lockout/Tagout procedures, attach test equipment and reapply power to test.

Quick over all check

The ABC7 Combi oven automatically records error conditions that may occur during use. Also, the Service Mode provides a quick way of checking the condition of the oven. It is recommended that any time an ABC7 oven is to be serviced, the service tech starts by running all tests in SERVICE MODE (1963) and to look at the error log to make note of any recent error codes that have been saved.

Troubleshooting Using Error Codes

Check which ERROR CODES are logged.

NOTE: When an error has been corrected, that error code still remains in the log. It is important to note what the current cooking hour is and what cooking hour the error code was recorded.

Example

1. The current number of cooking hours on the oven is 100.

NOTE: Temperature display shows HRS, Timer display is flashing 0000 and the humidity display is flashing 100.

2. The school uses the oven 6 hours a day.
3. Error E1 happened at hour 75.
4. This means the error occurred 4 working days earlier.

Error Code	Symptom	Possible Cause	Action
E0	<p>Oven does not operate.</p> <p>When the error occurs, the oven shuts down and E0 shows in the temperature display along with a constant error beep.</p>	<ol style="list-style-type: none"> 1. High limit thermostat open. 2. K1 Contactor Aux contacts 3. Fuse F4, fuse link in terminal block. 4. Oven installed with not enough clearance. 	<ol style="list-style-type: none"> 1. Verify High limit shaft is turned clockwise until it stops. 2. Check contactor K1 for proper operation. 3. In <u>Service Mode (1963)</u>: <ol style="list-style-type: none"> A. Run (S5) to check the current status of the high limit. B. Run (rd1) to check the current temp of the oven cavity. 4. In <u>CONFIGURATION MODE (1972) ELECTRIC</u>: <ol style="list-style-type: none"> A. Check the setting of (P15). <ol style="list-style-type: none"> 1) If the setting of (P15) is set to 482° the high limit must be the 582° high limit thermostat. <p>NOTE: The older version of the high limit thermostat had yellow painted on the tip of the shaft.</p> 5. Check to make sure there is restriction to air flow for cooling and no other heat source that would raise the temperature of the oven.
E1	<p>Oven does not operate.</p> <p>When the error occurs, the oven shuts down and E1 shows in the temperature display along with a constant error beep.</p>	<ol style="list-style-type: none"> 1. Convection fan motor is getting too hot and its thermal overload trips. 2. 6.25-amp fuse (F7) blows on the Motor Drive Board. 3. Cooling fan F3 not running or running in the wrong direction. 4. R1 interlock relay. 5. R6 solid state relay. 6. Motor Drive board. 7. C1 capacitor. 	<ol style="list-style-type: none"> 1. In <u>Service Mode (1963)</u>: <ol style="list-style-type: none"> A. Run (F1) convection fan test. B. Run (F3) convection fan reverse test C. Run (Y6) cooling fans test. <ol style="list-style-type: none"> 1) The Timer display alternates between CFan and a value. A value of 99 means all three fans are running. 2) Make sure cooling fan F3 is blowing in towards the convection fan motor. 2. With no power applied, check to see if the convection fan turns freely. 3. Check to make sure there is restriction to air flow for cooling and no other heat source that would raise the temperature of the oven.

Error Code	Symptom	Possible Cause	Action
E2	Oven does not operate. When the error occurs the oven shuts down and E2 shows in the temperature display along with a constant error beep.	<ol style="list-style-type: none"> 1. RTD Probe. 2. Main board. 	<ol style="list-style-type: none"> 1. In <u>Service Mode (1963)</u>: <ol style="list-style-type: none"> A. Run (rd1) to check the reading from the temperature probe. NOTE: If a reading of E2 is seen the value is out of range and possible damage board. B. Perform <u>TEMPERATURE SENSOR (RTD1) TEST</u>. C. Replace main board.
E4	Oven not operating properly, (intermittent or erratic).	<ol style="list-style-type: none"> 1. Cooling fan F2 not running or running in the wrong direction. 	<ol style="list-style-type: none"> 1. In <u>Service Mode (1963)</u>: <ol style="list-style-type: none"> A. Run (Y6) Cooling fans test. <ol style="list-style-type: none"> 1) The Timer display alternates between CFan and a value. A value of 99 means all three fans are running. 2) Make sure cooling fan F2 is blowing down, drawing air through the electrical panel. B. Check to make sure there is restriction to air flow for cooling and no other heat source that would raise the temperature of the oven.
E5	Uses too much water, or does not temper drain water.	<ol style="list-style-type: none"> 1. Drain tempering probe. 2. Water drain condensate valve. 3. Main board. 	<ol style="list-style-type: none"> 1. In <u>Service Mode (1963)</u>: <ol style="list-style-type: none"> A. Run (Y9) Water drain condensate valve test. NOTE: When the test is running the Timer display toggles between three things: H2dr, which is the name of the test, the drain tempering probes temperature reading, and a value that indicates the valve is energized (should be a valve of 6 plus or minus 1).
E6	Not cooking properly. (Convection fan not working).	<ol style="list-style-type: none"> 1. Motor board. 2. Solid State relay. 	<ol style="list-style-type: none"> 1. In <u>Service Mode (1963)</u>: <ol style="list-style-type: none"> A. Run (F1) Convection Fan test. <ol style="list-style-type: none"> 1) Check LEDs on motor board. <ul style="list-style-type: none"> • If red LED is on when the motor is not running, replace motor board. • If yellow LED is on and motor does not run, replace Solid State Relay.
E7	An electric oven thinks it's gas.	<ol style="list-style-type: none"> 1. Main board. 	<ol style="list-style-type: none"> 1. In <u>Service Mode (1963)</u>: <ol style="list-style-type: none"> A. Run (S11) Auto Detect test.

Error Code	Symptom	Possible Cause	Action
E8	Gas only		
E9	Gas only		
E10	Gas only		
E11	Gas only		
E12	Gas only		
E13	Gas only		
E15	Poor cooking, error dot in the upper left hand corner of the humidity display.	<ol style="list-style-type: none"> 1. Setscrew that holds damper shaft to vent motor is loose. 2. Vent motor. 3. Vent switches. 4. Vent blocked. 	<ol style="list-style-type: none"> 1. Perform <u>CAVITY VENT SWITCH TEST AND ADJUSTMENT</u>. NOTE: Typically, when there is a vent problem, E15, motor is spinning, but shaft is not turning which prevents the detent from shutting off the switch. 2. Inspect the vent tube to make sure it is not blocked in some way.

Error Code	Symptom	Possible Cause	Action
<p>E16 firmware revisions: 8-11-14 or 2-25-14 Only</p>	<p>Does not steam in Combi mode. Error dot in the upper left hand corner of the humidity display.</p>	<ol style="list-style-type: none"> 1. Oxygen sensor. 2. Oxygen sensor board. 3. Main board. 4. Missing ferrite. 	<ol style="list-style-type: none"> 1. In <u>Service Mode (1963)</u>: <ol style="list-style-type: none"> A. Run (o3) Oxygen board / Oxygen sensor status. <p>00 / oFF</p> <ul style="list-style-type: none"> • Oxygen board not transmitting a status. • Check connections. • Run (o1) oxygen sensor power test. <p>If test passes, (board has power, but cannot communicate), replace Oxygen sensor board.</p> <p>01 / HT</p> <ul style="list-style-type: none"> • Oxygen board is heating the oxygen sensor. • Wait 3 minutes for warming after power is applied. <ul style="list-style-type: none"> • Check sensor connections. • Make sure ferrite is in place. • Check routing of cable going to Oxygen Sensor. • Replace sensor. <p>02 / rdY</p> <ul style="list-style-type: none"> • Oxygen board is ready and transmitting humidity data from sensor. <p>03 / Cal</p> <ul style="list-style-type: none"> • Oxygen board can't calibrate. • Replace Oxygen board. <p>04 / Cur (Current error)</p> <ul style="list-style-type: none"> • Oxygen board can't sense current in oxygen sensor heater. • Check for disconnected sensor. • Check for damaged extension cable. • Replace sensor.
<p>E18</p>	<p>Does not steam in Combi mode. Error dot in the upper left hand corner of the humidity display.</p>	<ol style="list-style-type: none"> 1. Fuse F1 (fuse link in terminal block). 2. Fuse F8 (on Oxygen board). 3. R3 relay. 	<ol style="list-style-type: none"> 1. Check fuses

Error Code	Symptom	Possible Cause	Action
E20	No obvious symptom.	1. Cooling Fan	1. In <u>Service Mode (1963)</u> : A. Run (Y6) Cooling fans test. NOTE: The Timer display alternates between CFan and a value. A value below 65 means at least one fan is not running.
E21	Motor speed control error. Motor only runs on maximum speed, but other speeds won't work.	1. Main board. 2. Motor board. 3. Ribbon Cable.	1. In <u>Service Mode (1963)</u> : A. Run (F1) motor speed test at speed 7 (maximum speed). Verify Amber LED on motor board lights up. B. Run (F1) motor test at speed 3 (slowest speed). C. Verify Amber LED on motor board lights up. D. Amber light on at speed 7, but not on at speed 3, 4, 5, or 6, indicates that part of the motor speed control circuit (on either the motor board or main board) is inoperable.
E22	Does not steam in Combi mode. Error dot in the upper left of humidity display.	1. Intermittent electrical noise. 2. Incorrect alignment of the 10-pin header (oxygen board to main board). 3. Oxygen sensor board. 4. Main board.	1. In <u>Service Mode (1963)</u> : 2. Run (o1) power test. A. Verify "00/on". 3. Run (o3) Oxygen board/ Oxygen sensor status. A. 02/rdY status: If power is on and status reads ready, there was a prior communication dropout that is now restored. B. 00/oFF If power on and status reads off, then there is a NO communication, oxygen board is not transmitting a status. <ul style="list-style-type: none"> • Check the alignment of the 10 pin header. • Replace oxy board. • Replace main board.

Error Code	Symptom	Possible Cause	Action
E23	<p>Does not steam in Combi mode.</p> <p>Error dot in the upper left of humidity display.</p>	<ol style="list-style-type: none"> 1. Intermittent noise. 2. Oxygen sensor board. 	<ol style="list-style-type: none"> 1. In <u>Service Mode (1963)</u>: 2. Run (o1) power test. <ol style="list-style-type: none"> A. Verify 00/on. 3. Run (o3) Oxygen board/ Oxygen sensor status. <ol style="list-style-type: none"> A. 02/rdY status: If power is on and status reads ready, there was a prior communication error (unrecognized error received) that is now restored. B. No status: Bad communication (unrecognized status) received from oxygen board. <ul style="list-style-type: none"> • Replace oxygen board.
E24	<p>Does not steam in Combi mode.</p> <p>Error dot in the upper left of humidity display.</p> <p>"Actual" humidity reads 100% when oven is not steaming.</p>	<ol style="list-style-type: none"> 1. Damaged oxygen sensor extension cable. 2. Oxygen sensor plug not fully seated. 3. Damaged oxygen sensor "stuck" at 100%. 	<ol style="list-style-type: none"> 1. Check for damage to Oxygen sensor extension cable. Hot surfaces or sharp edges can damage the wires. 2. Check for solid connection of oxygen sensor to mating connector. 3. Wipe out excess moisture and water droplets from the inside of the cavity. 4. Open the door. 5. In <u>Service Mode (1963)</u>: 6. Run (F1) motor speed test at speed 7 (maximum speed) for approximately 1 minute to evacuate moisture from cavity. 7. Run (o4) Oxygen sensor data test. It should read <20.0% (depending on altitude) with completely dry cavity in a typical room. <ul style="list-style-type: none"> • Replace oxygen sensor. • Replace oxygen sensor extension cable.

Error Code	Symptom	Possible Cause	Action
E25/E28	Does not steam in Combi mode. Error dot in the upper left of humidity display.	<ol style="list-style-type: none"> 1. Damaged Oxygen Sensor extension cable. 2. Intermittent electrical noise. 3. Oxygen sensor plug not fully seated. 4. Wire routing. 5. Missing ferrite. 6. Oxygen sensor. 7. Oxygen sensor board. 	<ol style="list-style-type: none"> 1. Check for damage to oxygen sensor extension cable. <ol style="list-style-type: none"> A. Hot surfaces or sharp edges can damage the wires. 2. Check for solid connection of oxygen sensor to mating connection. 3. Check for proper routing of cables. 4. Verify ferrite is in place. 5. In <u>Service Mode (1963)</u> run O3 oxygen board/oxygen sensor status. <ol style="list-style-type: none"> A. Status 02/rdY. <ul style="list-style-type: none"> • If status reads ready there was a prior underheat or overheat condition that has now cleared. B. Status 01/HT. <ul style="list-style-type: none"> • Wait 3 minutes after any kind of power on. • If status <u>continually</u> reads 01, underheating, there is an inability for the sensor board pair to regulate the sensor's internal heater. C. Status 05/HT. <ul style="list-style-type: none"> • If status <u>continually</u> reads 05, overheating, there is an inability for the sensorboard pair to regulate the sensor's internal heater. <p>NOTE: Oxygen sensor heater regulation is sensitive to intermittent electrical noise. Sporadic E25 or E28 errors can be expected. Only replace the following components if the o3 test reports the status 01 or status 05 <u>continually</u>.</p> 6. Replace oxygen sensor extension cable. 7. Replace oxygen sensor. 8. Replace oxygen sensor board.

Error Code	Symptom	Possible Cause	Action
E26	Does not steam in Combi mode. Error dot in the upper left of humidity display	1. Oxygen Sensor board.	<ol style="list-style-type: none"> 1. In <u>Service Mode (1963)</u>: 2. Run (o1) power test. Verify 00/on. 3. Run (o3) Oxygen board/ Oxygen sensor status. <ul style="list-style-type: none"> • 02/rdY status: If power is on and status reads ready, condition is cleared, and no action needed. • 03/cal status: Oxygen board can't calibrate itself. Replace Oxygen board.
E27	Does not steam in Combi mode. Error dot in the upper left of humidity display.	<ol style="list-style-type: none"> 1. Damaged Oxygen sensor extension cable. 2. Oxygen Sensor plug not fully seated. 3. Oxygen sensor. 4. Oxygen sensor board. 	<ol style="list-style-type: none"> 1. Check for damages to the Oxygen sensor extension cable. <ul style="list-style-type: none"> • Hot surfaces or sharp edges can damage the wires. • Check for solid connection of Oxygen sensor to mating connector. 2. Run (o3) Oxygen Sensor Status test in <u>Service Mode (1963)</u>. <ol style="list-style-type: none"> A. Status 04: oxygen board is sensing an open circuit to the sensor. <ul style="list-style-type: none"> • Replace oxygen sensor extension cable. • Replace oxygen sensor. • Replace oxygen sensor board.
E28	Refer to <u>E25</u> .		
E29	High limit trips. Heat contactor does not turn off. Runaway oven heat.	Oven temperature sensor damaged and reports an abnormally low reading (for example <40° F).	<ol style="list-style-type: none"> 1. In <u>Service Mode (1963)</u>: <ol style="list-style-type: none"> A. Run "rd1" to check the reading from the temperature probe. <p>NOTE: rd1 reading of <40°F indicates a short.</p> B. Perform <u>TEMPERATURE SENSOR (RTD1) TEST</u>. 2. Check wiring at TB2. 3. Replace oven temperature sensor.
E888	Error 888 displayed on all screens.	Malfunction with ribbon cable or main board.	Check ribbon cable. Replace main board.

Troubleshooting by Symptom

NOTE: It is highly recommended that you check the error log, and run the test available in reference to error.

SYMPTOM	POSSIBLE CAUSE
<p>Oven completely inoperative. No display on display board or erratic display.</p>	<ol style="list-style-type: none"> 1. Facilities main circuit breaker open. 2. Oven power cord unplugged. 3. Fuse F3. 4. Incorrect wiring of On/Off switch. 5. Ribbon cable going from Main board to Display board not seated correctly. 6. Display board inoperative. 7. Transformer T1 malfunctioned. 8. Control board inoperative.
<p>Oven does not operate. Display is on.</p>	<ol style="list-style-type: none"> 1. Encoder malfunction. 2. In <u>Service Mode (1963)</u>: <ol style="list-style-type: none"> A. Check error log for E0, E1 and E2 errors. NOTE: If any of the 3 errors are logged, follow <u>Troubleshooting using Error Codes</u>. B. Run (S6) Door test. 3. Check that the jumper (J5) on back of display board is on the correct set of pins. NOTE: The jumper should be on the two pins closes to the edge of the board. This is the 5V position.
<p>Oven operates. Door closed and convection fan inoperative.</p>	<ol style="list-style-type: none"> 1. In <u>Service Mode (1963)</u>: <ol style="list-style-type: none"> A. Check error log for E1errors. NOTE: If any E1 errors are logged, follow <u>Troubleshooting using Error Codes</u>. B. Run (S6) Door test.
<p>Oven operates. Door closed and oven cavity lights inoperative.</p>	<ol style="list-style-type: none"> 1. Reset control by powering oven off and unplugging from the wall outlet, then restarting. 2. Check fuse F2. 3. In <u>Service Mode (1963)</u>: <ol style="list-style-type: none"> A. Run (Y13) Oven Cavity door light test. <ol style="list-style-type: none"> 1) If all cavity light inoperative. <ul style="list-style-type: none"> • Check 12 volts from transformer. • Main Board. 2) If only one light out. <ul style="list-style-type: none"> • Halogen light burned out.
<p>Oven operates. Door closed. Oven convection fan operates. Control heat on but oven does not heat.</p> <p>Possible error messages on Timer display.</p> <ul style="list-style-type: none"> • "No Heat" • "Door" 	<ol style="list-style-type: none"> 1. In <u>Service Mode (1963)</u>: <ol style="list-style-type: none"> A. Run (S6) Door test. B. Run (Y14 and Y15) Heating Element test. 2. Heating circuit malfunction.

SYMPTOM	POSSIBLE CAUSE
Oven cavity vent inoperative. There is dot in the upper left corner of the humidity display.	<ol style="list-style-type: none"><li data-bbox="693 203 1469 237">1. Perform <u>CAVITY VENT SWITCH TEST AND ADJUSTMENT</u>.<li data-bbox="693 237 1469 302">2. Inspect the vent tube to make sure it is not blocked in some way.

SYMPTOM	POSSIBLE CAUSE
<p>No steam or not enough steam.</p>	<ol style="list-style-type: none"> 1. Check water supply to unit. Verify water supply from source to back of unit. 2. Inspect the gray colored extension cable from to oxygen sensor to oxygen sensor board for damage. 3. Check the Error Log for occurrences of E22-E28 and follow troubleshooting accordingly. 4. In <u>Service Mode (1963)</u> verify (check PO) software revision is 4-24-17 or higher. Upgrade if necessary. 5. Verify proper operation of Oxygen sensor. <ol style="list-style-type: none"> A. Run (o1) Oxygen sensor power test. Verify power "on." B. Run (o3) Oxygen Board/sensor status test. Verify "rdy" status. C. Wipe out any standing water droplets, and run (F1) fan test with an open door for 1-2 minutes to evacuate any moisture. D. Run (o4) Oxygen sensor Data. It should read <20.0% (depending on altitude) with completely dry cavity in a typical room. 6. Verify water flows out of atomizer. <ol style="list-style-type: none"> A. Run (Y5) High Humidity test. Verify start/stop. B. Run (Y8) low Humidity test. Verify start/stop. <p>NOTE: Debris/excessive lime build up can clog valves.</p> 7. Verify proper cavity vent operation. <ol style="list-style-type: none"> A. Run (Y10) Cavity Vent test. <p>NOTE: Maladjustments causing intermittent vent stuck open, means steam and heat loss during cook.</p> 8. Verify proper door switch operation. <ol style="list-style-type: none"> A. Run (S6) Door test. <p>NOTE: Maladjustments causing intermittent door switch chattering, means steam and heat are turned off during cook.</p> 9. In cook mode, check "actual" oven temperature compared to setpoint. Turn temperature knob clockwise one indent only. <ul style="list-style-type: none"> • Oven must be within 50°F of setpoint or "augmented setpoint" for water valves to come on (for steam function). • Frozen product, valve issues, stuck (open) vent, underpowered (voltage/gas pressure) oven could all contribute to a >50°F drop in temperature. 10. Verify timer isnt expired. <p>NOTE: When timer expires, the steam but not heat turns off.</p> 11. Verify humidity knob is NOT set to "---" during cook. <ul style="list-style-type: none"> • Humidity setting of "---" means "no steam mode".

SYMPTOM	POSSIBLE CAUSE
	<ul style="list-style-type: none"> • Disable P28 in <u>CONFIGURATION MODE (1972) ELECTRIC</u>: <ol style="list-style-type: none"> 12. Check incoming voltage. 13. Check gas pressure. 14. Replace oxygen sensor. <p>NOTE: Refer to <u>CHECK OXYGEN SENSOR DATE CODE (REPLACEMENT SENSORS)</u>.</p>
<p>Excessive moisture in oven. Water runs continually from atomizer when not cooking.</p>	<ol style="list-style-type: none"> 1. Check water supply. <ol style="list-style-type: none"> A. Cycle water supply to unit off and back on again. <p>NOTE: Pressure conditions can hold water valves on.</p> B. Check for proper orientation of dual humidity valve. <p>NOTE: Water tubes to the top and electrical connections to the bottom. Correct valve orientation prevents a water “stuck on” condition.</p> C. Check for water pressure regulator malfunction. 2. Check the following in <u>Service Mode (1963)</u>: <ol style="list-style-type: none"> A. Verify the start/stop of the water flow out of atomizer. <ol style="list-style-type: none"> 1) Run (Y5) High Humidity test. 2) Run (Y8) low Humidity test. <p>NOTE: Debris can get stuck in valve and hold it open.</p> B. Verify proper cavity vent operation. <ol style="list-style-type: none"> 1) Run (Y10) Cavity Vent test. <p>NOTE: Maladjustments causing intermittent vent stuck closed, means heat humidity cannot escape during cooking.</p>

SYMPTOM	POSSIBLE CAUSE
<p>Incorrect heat / Oven temperature does not match setpoint.</p>	<ol style="list-style-type: none"> 1. In <u>CONFIGURATION MODE (1972) ELECTRIC</u>: <ol style="list-style-type: none"> A. Check P1 and P24. Refer to for details. 2. Perform <u>TEMPERATURE CALIBRATION - ELECTRIC</u>. 3. In <u>Service Mode (1963)</u>: <ol style="list-style-type: none"> A. Run (Y5) High Humidity test. B. Run (Y6) Low Humidity test. C. Run (F1) Convection Fan test. D. Run (S6) Door test. E. Run (Y14) Low Heat test. F. Run (Y15) High Heat test. 4. Do a <u>HEATING ELEMENTS RESISTANCE CHECK</u> 5. Heating circuit malfunction. <p>NOTE: Remember that the Overshoot feature engages during the first call for heat, and will overshoot the setpoint temporarily.</p>
<p>Uneven Baking.</p>	<ol style="list-style-type: none"> 1. In <u>Service Mode (1963)</u>: <ol style="list-style-type: none"> A. Run (F1) Convection Fan test. B. Run (F3) Convection Fan reverse test. C. Run (Y10) Cavity vent intake test. 2. Check intake vent and exhaust vents for blockage. 3. With no power applied, check to see if the convection fan turns freely. 4. Incorrect air baffle position. 5. Poor seal on door.
<p>Temperature of drain water too high.</p>	<ol style="list-style-type: none"> 1. In <u>CONFIGURATION MODE (1972) ELECTRIC</u>: <ol style="list-style-type: none"> A. Adjust parameter P25 and P26 (temperature based tempering). <ul style="list-style-type: none"> • Settings must match the drain type. • Settings can be further adjusted to suite customer requirements. <p style="text-align: center;">OR</p> B. P27 can be enabled for continuous time based tempering. 2. In <u>Service Mode (1963)</u>: <ol style="list-style-type: none"> A. Run (Y9) Water drain condensate valve test. <ul style="list-style-type: none"> • Check for proper operation of drain valve TC1 sensor.

SYMPTOM	POSSIBLE CAUSE
<p>Convection Fan not running.</p>	<ol style="list-style-type: none"> 1. In <u>Service Mode (1963)</u>: <ol style="list-style-type: none"> A. Check (P0) Firmware revision. <ul style="list-style-type: none"> • If earlier than 08-11-14 follow <u>FIRMWARE UPDATE PROCEDURE</u> B. Run (F1) Convection Fan test. <ul style="list-style-type: none"> • If red LED is on when the motor is not running, replace motor board. • If yellow LED is on and motor does not run, replace Solid State Relay.
<p>Cook-to-Probe knob feature not working (push button not functional).</p> <p>NOTE: (ABCx-xxxP devices only) Identified by the presence/absence of the socket on the front panel beneath the humidity knob)</p>	<ol style="list-style-type: none"> 1. In cook mode, Press & HOLD timer knob for approximately 3 seconds to toggle from the Timer Mode to the Cook-to-Probe Mode. 2. <u>CONFIGURATION MODE (1972) ELECTRIC</u>: <ol style="list-style-type: none"> A. Check P29 for proper set up. 1972 P29 enables multiple functions. Probe UI and fan UI must be separately enabled. Scroll timer knob to view P_UI then use humidity knob to enable. 3. In <u>SERVICE MODE (1963)</u>: <ol style="list-style-type: none"> A. Perform (pb) test for push button encoder functionality.
<p>Cook to probe not working correctly.</p> <p>Buzzer buzzed too early when cooking with probe.</p> <p>Buzzer never buzzes in cook to probe mode.</p> <p>Probe readings too high, too low, or vary wildly.</p> <p>Probe always reads about room temperature and won't change.</p>	<ol style="list-style-type: none"> 1. In cook mode, Press & HOLD timer knob for approximately 3 seconds to toggle from the Timer Mode to the Cook-to-Probe Mode as indicated by F shown in timer display. 2. Perform <u>EXTERNAL MEAT PROBE THERMOCOUPLE CALIBRATION</u>. 3. Inspect probe and probe wire for damage. 4. Check that probe is fully seated in socket on front panel. 5. Check TC2 connection at main board.
<p>Motor speeds are not changing (push button not functional).</p> <p>NOTE: ABCx-xxxP devices only) Identified by the presence/absence of the socket on the front panel beneath the humidity knob.</p>	<ol style="list-style-type: none"> 1. In cook mode, Press & HOLD humidity knob for approximately 3 seconds to toggle from the Humidity Mode to the Fan Speed Mode. 2. In <u>CONFIGURATION MODE (1972) ELECTRIC</u>: <ol style="list-style-type: none"> A. Check P29 for proper set up. 1972 P29 enables multiple functions. Probe UI and fan UI must be separately enabled. Scroll timer knob to view F_UI then use humidity knob to enable. 3. In <u>SERVICE MODE (1963)</u>: <ol style="list-style-type: none"> A. Perform (pb) test for push button encoder functionality.

SYMPTOM	POSSIBLE CAUSE
<p>Motor speeds are not changing (Push button functional).</p> <p>Motor only runs on maximum speed, but other speeds do not work.</p>	<p>NOTE: In cook mode, motor speed changes only take effect when the display defaults back to humidity mode. Also, in cook mode, set temperature is mapped to a humidity and fan speed 3. Changes in set temperature can reset motor to default speed F3.</p> <ol style="list-style-type: none"> 1. Verify in <u>CONFIGURATION MODE (1972) ELECTRIC</u> , P29 is enabled. 2. Motor relay malfunction (asynchronous turn-on feature malfunction). 3. Main board malfunction (zero cross function, check for E21 error). 4. Motor board malfunction (zero cross function, check for E21 error). 5. Ribbon cable malfunction.
<p>Speed settings need changed.</p>	<ol style="list-style-type: none"> 1. P12 changes speed settings for F1 and F2.
<p>Door too hard to close or pops open during steaming.</p>	<ol style="list-style-type: none"> 1. Perform DOOR TO CONTROL PANEL ALIGNMENT.